

USER MANUAL

vibro-meter®

SpeedSys300 ODS301  
overspeed detection system (ODS)



This document contains important information about products that are intended for use in potentially explosive atmospheres and/or safety-related applications.



Document reference MAODS301/E  
Edition 2 – June 2021

## REVISION RECORD SHEET

Edition	Date of issue	Written by / modified by	Description	Signature
1	03.05.2021	Peter Ward	Original edition.	PW
2	25.06.2021	Peter Ward	<p>Updated Figure 1-2, notably to include the bridge (short-circuit) required on the magnetic sensor input. Also updated the connector pinouts in 2.2 SpeedSys300 ODS301 module connectors (for consistency with the labelling used by the updated Figure 1-2).</p> <p>Changed the safety symbols in 3.3.9 Safety instructions – potentially explosive atmospheres to “STOP” WARNINGS (were “!” CAUTIONs).</p> <p>Updated Appendix B: ATEX certifications: Updated IBExU 20 ATEX 1157 (SpeedSys300 ODS301).</p> <p>Updated Appendix F: SpeedSys300 ODS301 Modbus register definitions to include some changes to Modbus register definitions, notably he Modbus registers at addresses: 0012,0108, 0563-0568, 3024, 4008, 4016-4019, 4500, 4512, 5026, 5046-5055, 5516-5554, 5638-5640 and 6004-6006. Also reformatted the tables (Table F-xx) to improve readability.</p>	PW

	Department	Name	Date	Signature
Technical content approved by	ATEX Manager	Pascal Kornatko	17.06.2021	PK
	Product Line Management	Michaël Hafner	21.06.2021	MH
Document released by	Technical Publications	Peter Ward	17.06.2021	PW

*The duly signed master copy of this page is stored by the Technical publications department of Meggitt SA and can be obtained by writing to Technical publications.*

## IMPORTANT NOTICES

All statements, technical information, and recommendations in this document which relate to the products supplied by Meggitt vibro-meter® (Meggitt SA) are based on information believed to be reliable, but unless otherwise expressly agreed in writing with Meggitt SA the accuracy or completeness of such data is not guaranteed. Before using this product, you must evaluate it and determine if it is suitable for your intended application. You should also check our website at [www.meggittsensing.com/energy](http://www.meggittsensing.com/energy) for any updates to data sheets, Ex certificates, product drawings, user manuals, service bulletins and/or other instructions affecting the product.

Unless otherwise expressly agreed in writing with Meggitt SA, you assume all risks and liability associated with use of the product. Meggitt SA takes no responsibility for any statements related to the product which are not contained in a current English language Meggitt SA publication, nor for any statements contained in extracts, summaries, translations or any other documents not authored and produced by Meggitt SA.

The certifications and warranties applicable to the products supplied by Meggitt SA are valid only for new products purchased directly from Meggitt SA or from an authorised distributor of Meggitt SA. Meggitt SA reserves the right to alter any part of this publication without prior notice.

## EXPORT CONTROL

The information contained in this document may be subject to export control regulations of the European Community, USA or other countries. Each recipient of this document is responsible for ensuring that the transfer or use of any information contained in this document complies with all relevant export control regulations. ECN N/A.

## COPYRIGHT

Copyright© 2021 Meggitt SA.

All rights reserved.

Published and printed by Meggitt SA in Fribourg, Switzerland.

The names of actual companies and products mentioned herein may be the trademarks of their respective owners.

The information contained in this document is subject to change without notice. This information shall not be used, duplicated or disclosed, in whole or in part, without the express written permission of Meggitt SA (Meggitt vibro-meter®).

THIS PAGE INTENTIONALLY LEFT BLANK

## PREFACE

### About this manual

This manual provides information on the SpeedSys300 ODS301 overspeed detection system (ODS), from Meggitt's vibro-meter<sup>®</sup> product line.

It offers information concerning the installation, configuration and general use of systems using ODS301 modules for overspeed, underspeed and/or acceleration detection and protection applications.

### About Meggitt and vibro-meter<sup>®</sup>

Meggitt PLC is a global engineering group, headquartered in the UK, specialising in the design and manufacture of high-performance components and systems for aerospace and energy markets.

The Meggitt facility in Fribourg, Switzerland, operates as the legal entity Meggitt SA (formerly Vibro-Meter SA). vibro-meter<sup>®</sup> is a product line of Meggitt that applies our core sensing and monitoring technologies to power generation, oil & gas and other industrial markets.

Meggitt SA produces a wide range of vibration, dynamic pressure, proximity, air-gap and other sensors capable of operation in extreme environments, electronic monitoring and protection systems, and innovative software for aerospace and land-based turbomachinery.

vibro-meter<sup>®</sup> products and solutions have been at the forefront of sensing and monitoring for more than 65 years and help keep machinery and equipment working safely, reliably and efficiently. This includes the SpeedSys300 ODS301 overspeed detection system (ODS) produced for the Meggitt vibro-meter<sup>®</sup> product line.

To learn more about Meggitt Switzerland, our proud tradition of innovation and excellence, and our solutions for energy markets and applications, visit the Meggitt vibro-meter<sup>®</sup> Energy website at [www.meggittsensing.com/energy](http://www.meggittsensing.com/energy)

## Who should use this manual?

This manual is intended for qualified personnel such as designers and operators of monitoring/control and/or protection systems in safety-related applications that use a SpeedSys300 ODS301 overspeed detection system (ODS).

---

**NOTE:** Personnel involved in the design, installation, operation and maintenance of Meggitt vibro-meter® systems are assumed to have the necessary technical training in safety, reliability, electronics and/or mechanical engineering (professional certificate/diploma or equivalent) to enable them to design, install, configure, use and/or maintain such systems correctly and safely.

---

## Adhere to the instructions!

The procedures described in this manual should be strictly adhered to in order to ensure that SpeedSys300 ODS301 overspeed detection system (ODS) modules and their associated equipment are properly installed. This ensures that measurement signals are reliable and systems function as intended.

The user should adhere to general safety procedures as well as general and specific machine constructor guidelines and instructions.

## Limitations of this document

Not all mounting and connecting possibilities are described in this manual. Nevertheless, several specific configurations are described in detail. These can often be adapted to specific applications (contact your local Meggitt representative or Meggitt SA for further information).

## Related documentation

Further information on products can be found in their corresponding data sheets, which are available from our website at [www.meggittsensing.com/energy](http://www.meggittsensing.com/energy) or can be obtained from your local Meggitt representative.

For further information on the SpeedSys300 ODS301 overspeed detection system (ODS), refer to the following Meggitt vibro-meter® documentation:

- *SpeedSys300 ODS301 overspeed detection system data sheet* (document reference DS 660-020-070-201A).

Operators of safety-related systems using the SpeedSys300 ODS301 overspeed detection system (ODS) should also refer to the following document:

- *SpeedSys300 ODS301 overspeed detection system safety manual* (pending).



**USE OF A SPEEDSYS300 ODS301 OVERSPEED DETECTION SYSTEM (ODS) IN A SAFETY-RELATED APPLICATION ASSUMES THAT THE INSTRUCTIONS AND RECOMMENDATIONS IN THE SPEEDSYS300 ODS301 OVERSPEED DETECTION SYSTEM (ODS) SAFETY MANUAL ARE IMPLEMENTED AS APPROPRIATE BY THE END USER.**

**FAILURE TO FOLLOW THE INSTRUCTIONS AND IMPLEMENT THE RECOMMENDATIONS IN THE SAFETY MANUAL MIGHT RESULT IN INJURY TO THE OPERATOR AND/OR THIRD PARTIES, AND/OR RESULT IN DAMAGE TO EQUIPMENT AND WILL INVALIDATE ANY WARRANTY.**

---

**NOTE:** To ensure that the latest version of documentation is being used, visit the Meggitt vibro-meter® Energy website at [www.meggittsensing.com/energy](http://www.meggittsensing.com/energy) and check for any updates. Alternatively, contact your local Meggitt representative.

---

THIS PAGE INTENTIONALLY LEFT BLANK

## SAFETY

### Symbols and styles used in this manual

The following symbols are used in this manual where appropriate:



#### The **WARNING** safety symbol

**THIS INTRODUCES DIRECTIVES, PROCEDURES OR PRECAUTIONARY MEASURES WHICH MUST BE EXECUTED OR FOLLOWED. FAILURE TO OBEY A WARNING MIGHT RESULT IN INJURY TO THE OPERATOR AND/OR THIRD PARTIES, AND/OR RESULT IN DAMAGE TO EQUIPMENT.**



#### The **CAUTION** safety symbol

**This draws the operator's attention to information, directives or procedures which must be executed or followed. Failure to obey a caution can result in damage to equipment.**



#### The **ELECTROSTATIC SENSITIVE DEVICE** symbol

**This indicates that the device or system being handled can be damaged by electrostatic discharges. See Handling precautions for electrostatic sensitive devices on page xii for further information.**

---

**NOTE:** This is an example of the NOTE paragraph style. This draws the operator's attention to complementary information or advice relating to the subject being treated.

---



Direct current



Signal 0 V (ground) terminal



Alternating current



Class II equipment



Direct and alternating current



Caution, general danger



Earth (ground) terminal



Caution, possibility of electric shock



Protective conductor (ground) terminal



Caution, hot surface



Frame or chassis (ground) terminal

## Equipment installed in potentially explosive atmospheres



THIS MANUAL COVERS EQUIPMENT THAT CAN BE CONNECTED TO PRODUCTS USED IN POTENTIALLY EXPLOSIVE ATMOSPHERES (HAZARDOUS AREAS), AS WELL AS EQUIPMENT THAT IS SUITABLE FOR ORDINARY APPLICATIONS (NON-EXPLOSIVE ATMOSPHERES) ONLY.

TO ENSURE THAT THE EQUIPMENT CAN BE SAFELY CONNECTED TO PRODUCTS USED IN POTENTIALLY EXPLOSIVE ATMOSPHERES (EX ZONES), IT IS ESSENTIAL TO:

- VERIFY THAT IT HAS THE SPECIAL MARKING DESCRIBED IN THE EX CERTIFICATES FOR THE PRODUCT.
- ADHERE TO THE CRITERIA DEFINED IN THE SAME EX CERTIFICATES.

AN “X” PLACED AFTER AN EX CERTIFICATE NUMBER IS USED TO INDICATE EQUIPMENT THAT IS SUBJECT TO SPECIFIC CONDITIONS OF USE (SPECIAL CONDITIONS FOR SAFE USE), WHICH ARE SPECIFIED IN THE CERTIFICATE. A “U” PLACED AFTER AN EX CERTIFICATE NUMBER IS USED TO INDICATE COMPONENTS THAT ARE SUBJECT TO A SCHEDULE OF LIMITATIONS, WHICH ARE SPECIFIED IN THE CERTIFICATE.

FOR FURTHER INFORMATION, SEE THE EX CERTIFICATES IN THE APPENDICES OF THIS MANUAL. (THE EX CERTIFICATES ARE ALSO AVAILABLE FROM OUR WEBSITE AT [WWW.MEGGITTSENSING.COM/ENERGY](http://WWW.MEGGITTSENSING.COM/ENERGY))

SEE ALSO 7 MAINTENANCE.

## Important remarks on safety-related applications



USE OF A SPEEDSYS300 ODS301 OVERSPEED DETECTION SYSTEM (ODS) IN SAFETY-RELATED APPLICATIONS (FUNCTIONAL-SAFETY CONTEXTS) ASSUMES THAT THE INSTRUCTIONS AND RECOMMENDATIONS IN THIS MANUAL ARE IMPLEMENTED AS APPROPRIATE BY THE END USER.

FAILURE TO FOLLOW THE INSTRUCTIONS AND IMPLEMENT THE RECOMMENDATIONS IN THIS MANUAL MIGHT RESULT IN INJURY TO THE OPERATOR AND/OR THIRD PARTIES, AND/OR RESULT IN DAMAGE TO EQUIPMENT AND WILL INVALIDATE ANY WARRANTY.

## Important remarks on safety



FAILURE TO FOLLOW THE INSTRUCTIONS AND IMPLEMENT THE RECOMMENDATIONS IN THIS MANUAL MIGHT RESULT IN INJURY TO THE OPERATOR AND/OR THIRD PARTIES, AND/OR RESULT IN DAMAGE TO EQUIPMENT AND WILL INVALIDATE ANY WARRANTY.



Read this manual carefully and observe the safety instructions before installing and using the equipment described.

By doing this, you will be aware of the potential hazards and be able to work safely, ensuring your own protection and also that of the equipment.

Every effort has been made to include specific safety-related procedures in this manual using the symbols described above. However, operating personnel are expected to follow all generally accepted safety procedures.

All personnel who are liable to operate the equipment described in this manual should be trained in the correct safety procedures.

Meggitt does not accept any liability for injury or material damage caused by failure to obey any safety-related instructions or due to any modification, transformation or repair carried out on the equipment without written permission from Meggitt SA. Any modification, transformation or repair carried out on the equipment without written permission from Meggitt SA will invalidate any warranty.

## Electrical safety and installation



**WHEN INSTALLING A SPEEDSYS300 ODS301 OVERSPEED DETECTION SYSTEM (ODS), OBSERVE ALL SAFETY (WARNING AND CAUTION) STATEMENTS IN THIS MANUAL AND FOLLOW ALL NATIONAL AND LOCAL ELECTRICAL CODES.**

**ONLY TRAINED AND QUALIFIED PERSONNEL (SUCH AS A QUALIFIED/LICENSED ELECTRICIAN) SHOULD BE ALLOWED TO INSTALL OR REPLACE THIS EQUIPMENT.**

**CHECK NATIONAL AND LOCAL ELECTRICAL CODES, REGULATIONS AND DIRECTIVES BEFORE WIRING.**

**ODS301 MODULES MUST BE DIRECTLY AND PERMANENTLY CONNECTED TO LIVE EARTH (PE), KNOWN AS AN EQUIPMENT GROUNDING CONDUCTOR IN THE US NATIONAL ELECTRICAL CODE, USING THE EARTH CONDUCTOR OF THE EXTERNAL MAINS POWER SUPPLY LEAD (POWER CORD), IN ORDER TO HELP PREVENT THE RISK OF ELECTRIC SHOCK.**

**SELECT CABLE WIRE SIZES AND CONNECTORS (CURRENT-CARRYING CAPACITY), INCLUDING THE EXTERNAL MAINS POWER SUPPLY LEAD (POWER CORD), TO MEET THE REQUIREMENTS OF THE APPLICATION IN ACCORDANCE WITH THE APPLICABLE NATIONAL AND LOCAL ELECTRICAL CODES.**

**CHECKS TO ENSURE ELECTRICAL SAFETY SHOULD BE CARRIED OUT BY A COMPETENT PERSON.**

**FAILURE TO FOLLOW THESE INSTRUCTIONS CAN RESULT IN DEATH, SERIOUS INJURY, AND/OR EQUIPMENT DAMAGE.**

## General handling precautions

Meggitt's vibro-meter<sup>®</sup> ODS301 modules are rugged devices which can withstand a certain amount of careless handling. Nevertheless, certain precautions should be taken.



**Read the following recommendations carefully before handling ODS301 modules.**

- Do not drop the module onto a hard surface or subject it to violent shocks.
- Protect the module using suitable protective materials when it is being handled, stored or transported. Remove all protective materials before installation and use of the product.
- When storing and using the equipment, adhere to the environmental specifications (temperature, humidity) quoted in the appropriate data sheet.
- See also the Handling precautions for electrostatic sensitive devices on page xii.

## Handling precautions for electrostatic sensitive devices

Certain devices used in electronic equipment can be damaged by electrostatic discharges resulting from built-up static electricity. Because of this, special precautions must be taken to minimise or eliminate the possibility of these electrostatic discharges occurring.



**Read the following recommendations carefully before handling electronic circuits, printed circuit boards or modules containing electronic components.**

- Before handling electronic circuits, discharge the static electricity from your body by touching and momentarily holding a grounded metal object (such as a pipe or cabinet).
- Avoid the build-up of static electricity on your body by not wearing synthetic clothing material, as these tend to generate and store static electric charges. Cotton or cotton blend materials are preferred because they do not store static electric charges.
- Do not handle electronic circuits unless it is absolutely necessary. Only hold modules/cards by their handles or panels.
- Do not touch printed circuit boards, their connectors or their components with conductive devices or with your hands.
- Put the electronic circuit, printed circuit board or module containing electronic components into an antistatic protective bag immediately after removing it from a system.

## Replacement parts and accessories



**Use only approved replacement parts and accessories.**

**Do not connect with incompatible products or accessories.**

**Only use replacement parts and accessories intended for use with SpeedSys300 ODS301 overspeed detection systems that have been approved by Meggitt SA.**

**Using incompatible replacement parts and accessories could be dangerous and may damage the equipment or result in injury.**

For information on replacement parts and accessories:

- Visit the Meggitt vibro-meter® website at [www.meggittsensing.com/energy](http://www.meggittsensing.com/energy)
- Contact your local Meggitt representative.

## TABLE OF CONTENTS

TITLE PAGE .....	i
REVISION RECORD SHEET .....	ii
IMPORTANT NOTICES.....	iii
PREFACE .....	v
SAFETY.....	ix
TABLE OF CONTENTS .....	xiii
<b>1 INTRODUCTION TO THE SPEEDSYS300 ODS301 OVERSPEED DETECTION SYSTEM.....</b>	<b>1-1</b>
1.1 System overview.....	1-1
1.1.1 Introduction.....	1-1
1.1.2 SIL safety .....	1-4
1.1.3 Safety related and non-safety related functionality.....	1-4
1.1.4 Software .....	1-5
1.2 Applications information .....	1-5
1.2.1 Applications .....	1-5
1.2.2 Intended use.....	1-5
1.3 Parts and accessories.....	1-6
1.4 Environmental conditions/specifications .....	1-6
<b>2 OVERVIEW OF THE SPEEDSYS300 ODS301 MODULE HARDWARE .....</b>	<b>2-1</b>
2.1 SpeedSys300 ODS301 module LEDs .....	2-1
2.2 SpeedSys300 ODS301 module connectors .....	2-3
2.2.1 Removing and inserting screw-terminal connectors.....	2-13

<b>3</b>	<b>INSTALLATION OF A SPEEDSYS300 ODS301</b>	<b>3-1</b>
3.1	Module details	3-1
3.2	Installing a module	3-1
3.2.1	Mounting procedure	3-1
3.2.1.1	Mounting on a DIN rail	3-2
3.2.1.2	Removing from a DIN rail	3-2
3.3	Installation considerations	3-3
3.3.1	Ventilation	3-3
3.3.2	Power supply wiring	3-4
3.3.3	Grounding	3-4
3.3.4	Voting logic	3-4
3.3.4.1	1oo2 voting	3-5
3.3.4.2	2oo2 voting	3-8
3.3.4.3	2oo3 voting	3-10
3.3.5	Electrical connections	3-13
3.3.6	Installations in hazardous areas	3-13
3.3.7	Wiring diagram	3-14
3.3.8	Safety instructions – safety-related applications	3-15
3.3.9	Safety instructions – potentially explosive atmospheres	3-15
3.3.9.1	Category (1) G equipment	3-15
3.3.9.2	Category (1) D equipment	3-15
<b>4</b>	<b>CONFIGURATION OF A SPEEDSYS300 ODS301</b>	<b>4-1</b>
4.1	Software	4-1
4.1.1	Software versions	4-1
4.1.2	Computer system requirements	4-1
4.2	Software installation	4-1
4.3	Software user interface	4-1
4.4	Getting started	4-2
4.5	Module configuration	4-5
4.5.1	Reading a module's configuration	4-5
4.5.2	Loading and saving configuration files	4-5
4.5.3	Activating a configuration on a module	4-5
4.5.4	test 300.ssy configuration file	4-6
4.6	Access levels/permissions	4-6
4.6.1	Changing the Admin access level password	4-7

<b>5</b>	<b>COMMISSIONING OF A SPEEDSYS300 ODS301</b>	<b>5-1</b>
5.1	Configuration parameters and settings	5-1
5.2	Device tab	5-2
5.2.1	Device tab – Configuration user	5-2
5.2.2	Device tab – Configuration admin	5-3
5.2.3	Device tab – Password admin	5-3
5.3	Measurement tab	5-4
5.3.1	Measurement tab – Measurement	5-4
5.3.2	Measurement tab – Advanced settings	5-5
5.4	Output tab	5-7
5.4.1	Output tab – Digital outputs	5-7
5.4.2	Output tab – Analog output	5-9
5.5	Diagnostics tab	5-10
5.5.1	Diagnostics tab – Diagnostics	5-10
5.6	Process data tab	5-12
5.6.1	Process tab – Process data	5-12
5.6.2	Process tab – Digital outputs	5-13
5.6.3	Process tab – Speed plot	5-13
5.7	Device status tab	5-14
5.7.1	Device status tab – Diagnostic data	5-14
5.7.2	Device status tab – Error status	5-15
5.8	Report tab	5-16
5.8.1	Report tab – Content	5-16
5.9	Event log tab	5-17
5.9.1	Event log tab	5-17
5.10	Programming parameters	5-19
<b>6</b>	<b>MODBUS COMMUNICATIONS WITH A SPEEDSYS300 ODS301</b>	<b>6-1</b>
6.1	Introduction	6-1
6.2	Modbus	6-2
6.2.1	Modbus RTU	6-2
6.3	Modbus register definitions	6-3
<b>7</b>	<b>MAINTENANCE</b>	<b>7-1</b>
7.1	General	7-1
7.2	Requirements for equipment used in potentially explosive atmospheres	7-1
7.3	Cleaning	7-1

<b>8</b>	<b>END-OF-LIFE PRODUCT DISPOSAL</b> .....	<b>8-1</b>
<b>9</b>	<b>SERVICE AND SUPPORT</b> .....	<b>9-1</b>
9.1	Contacting us .....	9-1
9.2	Technical support .....	9-1
9.3	Sales and repairs support .....	9-1
9.4	Customer feedback .....	9-2
	Energy product return form .....	9-4
	Energy customer feedback form .....	9-7
<b>A</b>	<b>APPENDIX A: ENVIRONMENTAL SPECIFICATIONS</b> .....	<b>A-1</b>
<b>B</b>	<b>APPENDIX B: ATEX CERTIFICATIONS</b> .....	<b>B-1</b>
<b>C</b>	<b>APPENDIX C: IECEX CERTIFICATIONS</b> .....	<b>C-1</b>
<b>D</b>	<b>APPENDIX D: FREQUENTLY ASKED QUESTIONS (FAQ)</b> .....	<b>D-1</b>
D.1	The SpeedSys300 software cannot communicate with my SpeedSys300 ODS301 module. What do I need to check? .....	D-1
D.2	How do I use a Meggitt vibro-meter® TQxxx/IQSxxx proximity measurement chain as the sensor input to a SpeedSys300 ODS301 module? .....	D-3
D.3	The Error LED on the front panel of the SpeedSys300 ODS301 module is showing RED. How do I determine the problem? .....	D-5
D.4	I am changing/programming the configuration of my SpeedSys300 ODS301 module but am not seeing the expected changes. What is wrong? .....	D-6
D.5	I am getting an analog output error even though I am not using this output/signal in my application. Why is this? .....	D-7
D.6	I am using the frequency (speed) output but cannot see an output signal. What should I check? .....	D-8
<b>E</b>	<b>APPENDIX E: SPEEDSYS300 ODS301 DIAGNOSTIC ERROR CODES</b> .....	<b>E-1</b>
E.1	Error codes .....	E-1

<b>F</b>	<b>APPENDIX F: SPEEDSYS300 ODS301 MODBUS REGISTER DEFINITIONS . . . . .</b>	<b>F-1</b>
F.1	Status and diagnostics . . . . .	F-1
F.1.1	Main status . . . . .	F-1
F.1.2	Control . . . . .	F-4
F.1.3	Current values . . . . .	F-5
F.1.4	Diagnostics data . . . . .	F-8
F.1.5	Slave communication status . . . . .	F-11
F.2	Parameters and configuration settings . . . . .	F-13
F.2.1	Admin password . . . . .	F-13
F.2.2	Device configuration – user . . . . .	F-13
F.2.3	Device configuration – admin . . . . .	F-14
F.2.4	Device configuration – factory . . . . .	F-15
F.2.5	Measurement configuration . . . . .	F-15
F.2.6	Diagnostics configuration – admin . . . . .	F-17
F.2.7	Diagnostics configuration – factory . . . . .	F-19
F.2.8	Output configuration – admin . . . . .	F-22
F.2.9	Output configuration – factory . . . . .	F-27

**THIS PAGE INTENTIONALLY LEFT BLANK**

# 1 INTRODUCTION TO THE SPEEDSYS300 ODS301 OVERSPEED DETECTION SYSTEM

This section provides an overview of the SpeedSys300 ODS301 overspeed detection system (ODS).

## 1.1 System overview

### 1.1.1 Introduction

The SpeedSys300 ODS301 overspeed detection system (ODS) system is an overspeed detection and protection system with additional monitoring from Meggitt's vibro-meter® product line.

It is a dedicated safety system for critical rotating machinery, designed using the latest technology and standards for one main purpose – to accurately detect overspeed, underspeed and/or acceleration in order to shutdown a machine and protect plant and personnel.

Figure 1-1 illustrates the SpeedSys300 ODS301 module hardware.

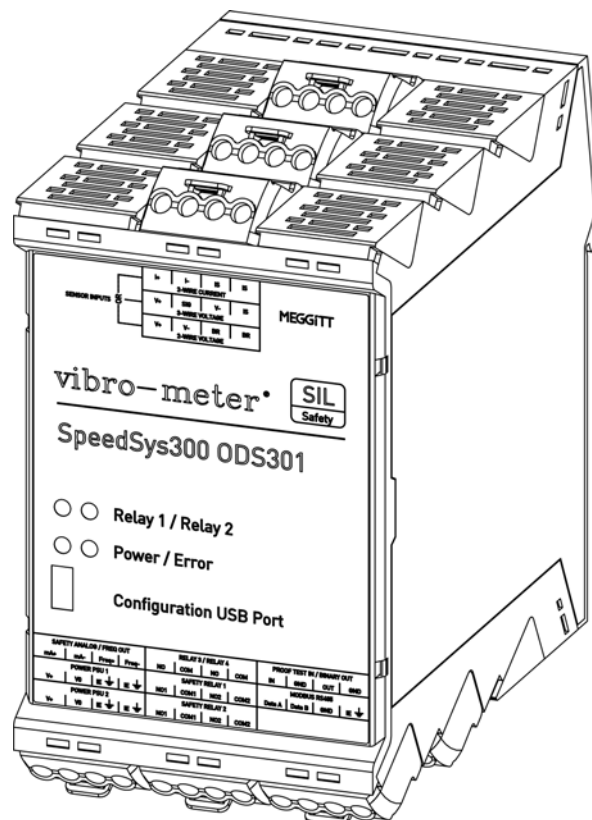

**Figure 1-1:** SpeedSys300 ODS301 module – three-quarter view

The SpeedSys300 ODS301 overspeed detection system is a fundamentally simple and highly robust system, designed for ease of use and reliable operation, with an exceptionally long proof-test interval of typically 10 years.

In operation, a shaft with a multi-toothed speed sensing surface, known as a speed wheel, is monitored by an industry-standard proximity, electronic or magnetic speed sensor. The sensor / measurement chain pulses (frequency) are counted by the SpeedSys300 ODS301 module and converted to a rotational speed measurement and an acceleration measurement.

The SpeedSys300 ODS301 module then compares the speed and acceleration measurements against the configured alarm limits, and will activate the safety relays – relay 1 and relay 2 – and additional (non-safety) relays – relay 3 and relay 4 – should a measurement exceed a limit. In general, the safety relays are used for critical alarms and the additional relays are used for non-critical alarms or other alarm/status information for the module.

The SpeedSys300 ODS301 module also uses the measured shaft rotational speed to drive the analogue 4 to 20 mA current loop output and update the frequency (speed) output, so that the information can be shared with external third-party systems such as a DCS or PLC, or even a simple display.

---

**NOTE:** The safety relays – relay 1 and relay 2 – and the analog output (4 to 20 mA) are safety outputs. More specifically, they are SIL certified and can be used for critical functions in machinery protection applications, such as initiating the shutdown (trip) of a machine.

---

Figure 1-1 illustrates the SpeedSys300 ODS301 module's hardware interfaces.

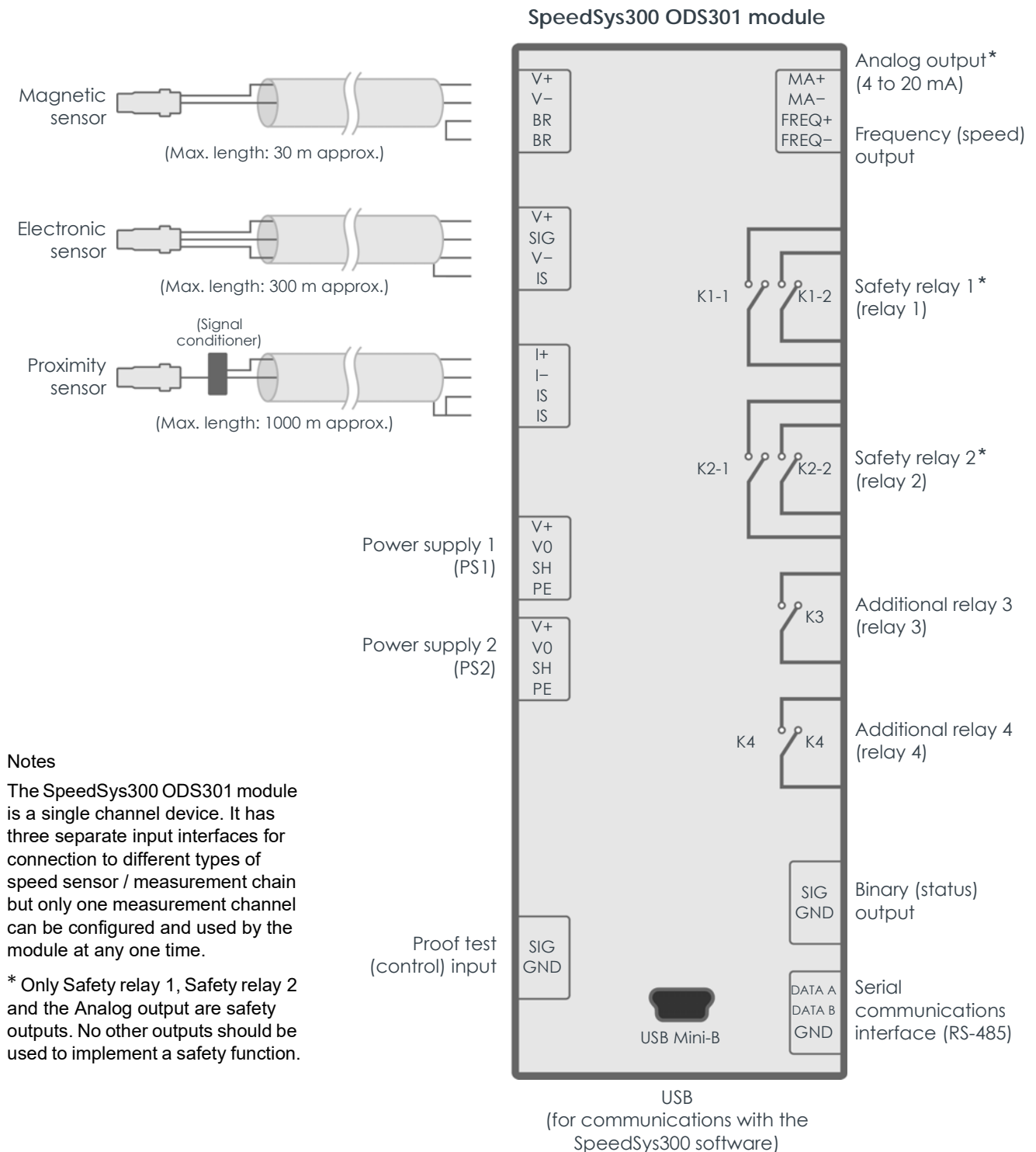

**Figure 1-2:** SpeedSys300 ODS301 module – interfaces

See also Figure 3-9 for more detailed information on the SpeedSys300 ODS301 module's electrical interfaces (sensor), suitable for wiring sensors / measurement chains to a module.

### 1.1.2 SIL safety

The SpeedSys300 ODS301 overspeed detection system is certified as SIL 2 and SIL 3 capable “by design”. Accordingly, the SpeedSys300 ODS301 module includes advanced self-monitoring and diagnostics (also known as built-in self-test (BIST)) to detect problems with the complete system. More specifically, the SpeedSys300 ODS301 module’s diagnostics can detect problems with the sensor / measurement chain, the cabling and the module itself. If the module detects any problems that could prevent it from implementing the configured safety function, the module will drive the safety relays – relay 1 and relay 2 – and the analog output to their safe states (de-energised and “zero” respectively) in order to ensure that the machine being monitored is always safe.

The SIL 2 design of the SpeedSys300 ODS301 module is SIL 3 capable when used in a redundant 2oo3 architecture. To implement the 2oo3 voting logic required by SIL 3 safety applications (and 1oo2 voting logic), the safety relay outputs from three ODS301 modules can either be wired directly together or they can be connected to an external system such as a safety PLC so that the required logic is evaluated before initiating a shutdown.

### 1.1.3 Safety related and non-safety related functionality

While the two safety relays – relay 1 and relay 2 – and analog output provide the safety related outputs, other SpeedSys300 ODS301 module functionality and outputs provide additional monitoring capability.

Two additional (non-safety) relays – relay 3 and relay 4 – and are available for alarm/status use depending on the requirements of the application. For example, the additional relays can be used to indicate when a measurement exceeds a non-critical limit or to communicate module status information, as configured using the application software.

A digital frequency (speed) output is available providing a digital output equivalent to the measured speed processed by the SpeedSys300 ODS301 module. This is typically used with a simple panel-mounted display in order to have a local digital readout of the speed for the machine being monitored.

A serial communications interface supporting Modbus RTU is available to share SpeedSys300 ODS301 module information with external third-party systems such as a DCS or PLC. The Modbus RTU interface is read only and cannot be used to change the configuration or operation of the ODS301 module.

While the proof-test interval of the SpeedSys300 ODS301 module itself is typically 10 years (depending on the application), a digital proof-test control input is available to effectively bypass the module’s safety relays for test purposes. This supports the proof test of a complete system containing an SpeedSys300 ODS301 module, for example, external systems such as a safety PLC. The SpeedSys300 ODS301 module proof test forces the module’s safety relays to open, in order to allow the safety chain that comes after the module / safety PLC to be verified.

---

**NOTE:** During a proof test, the SpeedSys300 ODS301 module cannot provide its normal machinery monitoring and protection functions. Accordingly, it is highly recommended that proof tests are only performed in accordance with the operating procedures for the machinery being monitored and that appropriate precautions are taken at the control system level (such as DCS or PLC).

---

Finally, a binary (status) output is available to indicate various aspects of the status of the system (sensor / measurement chain, cabling and ODS301 module itself). For example, the result of the advanced self-monitoring and diagnostics (BIST), overspeed, underspeed and/or acceleration can be assigned to this digital output (as they can be assigned to the relays).

### 1.1.4 Software

A SpeedSys300 ODS301 overspeed detection system is configured using the SpeedSys300 software – proprietary Windows® application software that is supplied with the SpeedSys300 ODS301 module. The computer running the software connects to the SpeedSys300 ODS301 via a USB connector on the front panel of the module.

In typical overspeed monitoring and protection applications, the SpeedSys300 software is connected to SpeedSys300 ODS301 modules for configuration and commissioning only, after which the system operates standalone.

## 1.2 Applications information

### 1.2.1 Applications

The SpeedSys300 ODS301 overspeed detection system solves overspeed safety requirements in a simple, reliable and cost-effective way. It is simple to install, configure and integrate into existing monitoring and protection applications.

For critical rotating machinery that requires monitoring and protection of both overspeed and vibration, the SpeedSys300 ODS301 module complements the VM600<sup>Mk2</sup>/VM600 and VibroSmart® machinery monitoring systems. As the safety critical speed system (SpeedSys300 ODS301 overspeed detection system) and any other systems (vibration and/or combustion) are completely separate (“segregated”), a SpeedSys300 ODS301 module can always be relied upon to shut down a machine, even in the event of a problem with other systems.

Because the SpeedSys300 ODS301 overspeed detection system is SIL certified “by design”, it is not limited to specific applications and there are fewer restrictions compared to equivalent “proven in use” systems. And being a new design, it uses the latest technology so there are no component supply or obsolescence issues.

For specific applications, contact your local Meggitt representative.

### 1.2.2 Intended use

The SpeedSys300 ODS301 overspeed detection system is an industrial and professional overspeed protection system intended for the protection and monitoring of critical and/or semi-critical turbomachinery in the Energy, Oil & Gas and Process industries. It is equally suitable for use with hydro or wind turbines and other similar applications that require an independent layer of protection.

The SpeedSys300 ODS301 module is designed for indoor use only and is meant to be placed inside a suitable industrial housing, field cabinet or other suitable enclosure. See Appendix A: Environmental specifications.

## 1.3 Parts and accessories

When a SpeedSys300 ODS301 overspeed detection system is ordered, the following system components are supplied:

- SpeedSys300 ODS301 module with 11 × removable screw-terminal connectors
- USB Type-A to USB Mini-B cable for computer to SpeedSys300 ODS301 module communications
- SpeedSys300 software (available via FTP).

---

**NOTE:** Refer to the *SpeedSys300 ODS301 overspeed detection system data sheet* for further information.

---

See also Replacement parts and accessories.

SpeedSys300 ODS301 overspeed detection systems can be supplied either blank (unconfigured) or configured for a specific application. Contact Meggitt SA for further information.

## 1.4 Environmental conditions/specifications

See Appendix A: Environmental specifications.

## 2 OVERVIEW OF THE SPEEDSYS300 ODS301 MODULE HARDWARE

This section provides an overview of the SpeedSys300 ODS301 module hardware. This includes functional information for certain elements such as status (LED) indicators, connector pinouts, etc.

### 2.1 SpeedSys300 ODS301 module LEDs

LEDs on the front panel of the SpeedSys300 ODS301 module are used to indicate the status and behaviour of the input signals to the module and the module itself.

In general:

- The Power LED indicates the general status of the module.
- The Error LED indicates the safety status of the module.
- The Relay 1 LED indicates the status of the module’s first safety relay (SAFETY RELAY 1).
- The Relay 2 LED indicates the status of the module’s second safety relay (SAFETY RELAY 2).

Table 2-1 provides detailed information on the behaviour of the SpeedSys300 ODS301 module’s Power and Error LEDs.

**Table 2-1:** Behaviour of SpeedSys300 ODS301 module’s Power and Error LEDs

SpeedSys300 ODS301 Power / Error LEDs		Description
Power (green)	Error (red)	
○	○	Module off
●	○	Module on and operating normally Note: The module has booted / started up correctly, including power-on self-test (POST).
●	●	Module diagnostic error – current problem Note: The SpeedSys300 ODS301 module’s diagnostics (BIST) is detecting a current problem with the input signal to the module or with the module itself. (This problem is happening now.)
●	● ○ ● ○ ●	Module diagnostic error – past problem Note: The SpeedSys300 ODS301 module’s diagnostics (BIST) has detected a past problem with the input signal to the module or with the module itself that is no longer present. (This problem happened in the past and is stored in error memory, so it has not yet been acknowledged/cleared.)
<p>Notes</p> <ul style="list-style-type: none"> <li>○ indicates a continuously off LED.</li> <li>● indicates a continuously on LED (green ● or red ●).</li> <li>● ○ ● ○ ● indicates a blinking LED (green ● or red ●).</li> </ul>		

---

**NOTE:** The SpeedSys300 ODS301 module's Error LED provide information on the safety relevant status of the input signal to the module and/or the module itself. The Error LED does not provide information on the operating status of the module, such as overspeed, underspeed and/or acceleration alarms.

---

Table 2-2 provides detailed information on the behaviour of the SpeedSys300 ODS301 module's Relay 1 and Relay 2 LEDs.

**Table 2-2:** Behaviour of SpeedSys300 ODS301 module's Relay 1 and Relay 2 LEDs

SpeedSys300 ODS301 Relay 1 / Relay 2 LEDs		Description
Relay 1 (yellow)	Relay 2 (yellow)	
○	---	Relay 1 is de-energised
●	---	Relay 1 is energised
---	○	Relay 2 is de-energised
---	●	Relay 2 is energised
Notes ○ indicates a continuously off LED. ● indicates a continuously on LED (yellow ●).		

## 2.2 SpeedSys300 ODS301 module connectors

As shown in Figure 1-1, the SpeedSys300 ODS301 module uses 11 removable screw-terminal connectors, as follows:

- 3 connectors on the top of the module for use with different types of sensor / measurement chain.

---

**NOTE:** The SpeedSys300 ODS301 module is a single channel device. It has three separate input interfaces for connection to different types of speed sensor / measurement chain but only one measurement channel can be configured and used by the module at any one time.

---

- 8 connectors on the bottom of the module for all other connections and interfacing, including power supply inputs, safety outputs and non-safety inputs/outputs.

The SpeedSys300 ODS301 module's housing features removable screw-terminal connectors that can be unplugged from the main body of the housing to simplify installation of the module.

Each connector consists of a male connector (socket on module) and a mating female connector (plug on wiring).

As shown in Figure 2-1, the front panel of the SpeedSys300 ODS301 module identifies the function of each connector and each connector's pinout (definition of terminals).



Figure 2-1: SpeedSys300 ODS301 module – front view

Figure 2-2 shows the relationship between the connector information on the front panel of the SpeedSys300 ODS301 module and the actual positions of the connectors on the top of the module itself. See also Figure 2-3.

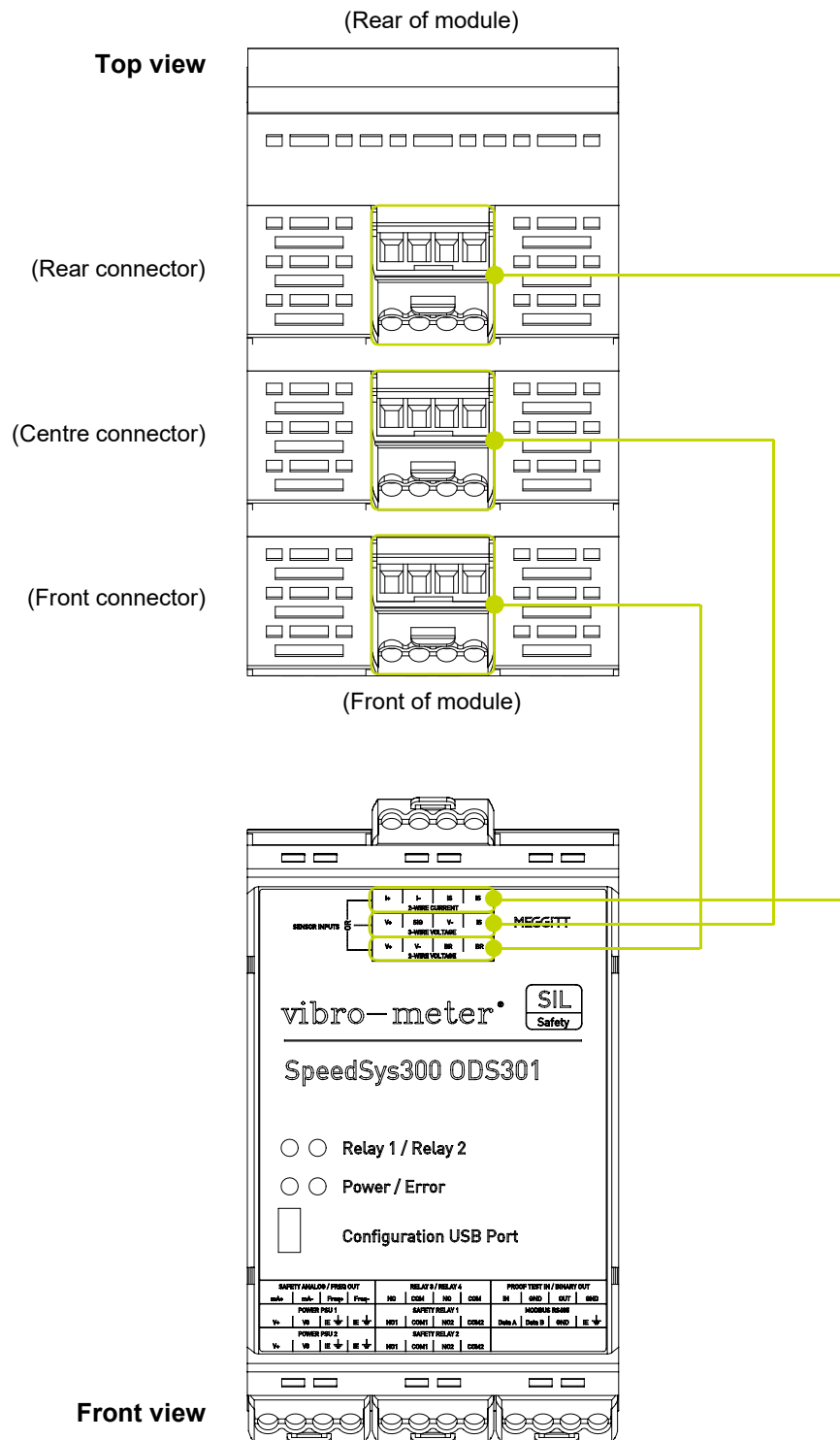

Figure 2-2: SpeedSys300 ODS301 module – top connectors

Figure 2-3 shows the relationship between the connectors on the top of the module and their pinouts as used in Table 2-3 to Table 2-5.



Figure 2-3: SpeedSys300 ODS301 module – top connector pinouts

Figure 2-4 shows the relationship between the connector information on the front panel of the SpeedSys300 ODS301 module and the actual positions of the connectors on the bottom of the module itself. See also Figure 2-5.

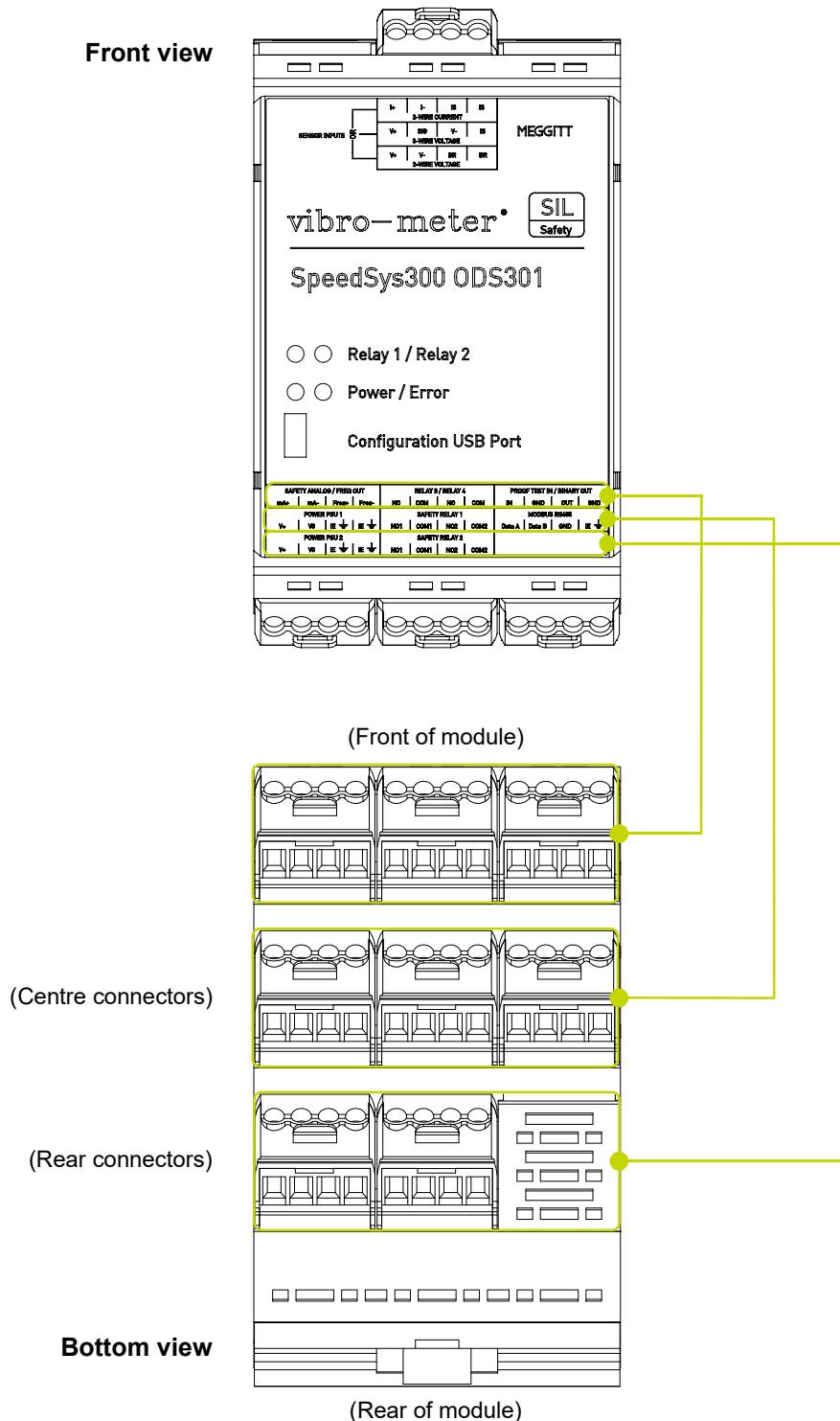

**Figure 2-4:** SpeedSys300 ODS301 module – bottom connectors

Figure 2-5 shows the relationship between the connectors on the bottom of the module and their pinouts as used in Table 2-6 to Table 2-13.

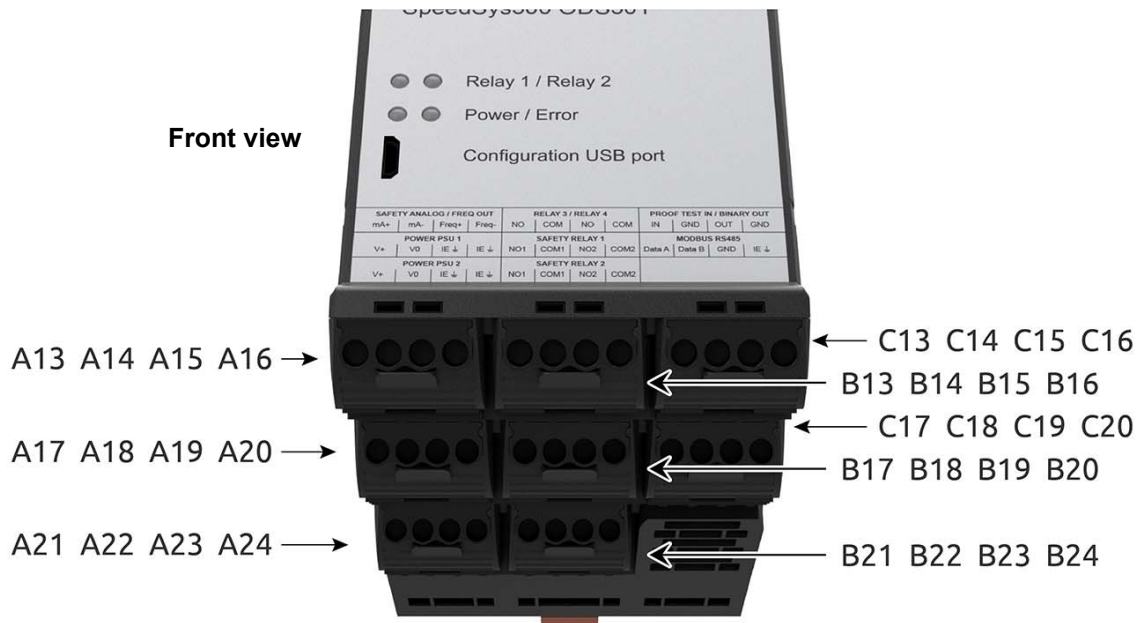

Figure 2-5: SpeedSys300 ODS301 module – bottom connector pinouts

Connector pinouts (definition of terminals) for the 3 connectors on the top of the module are given in Table 2-3 to Table 2-5.

**Table 2-3:** SpeedSys300 ODS301 module 2-WIRE VOLTAGE connector pinouts

SpeedSys300 ODS301 2-WIRE VOLTAGE connector				
Label	Pin	Name / function	Direction	Definition
2-WIRE VOLTAGE	B01	V+	I	Magnetic sensor interface: Signal
	B02	V-	I	Magnetic sensor interface: GND
	B03	BR	B	Bridge (short-circuit) to B04
	B04	BR	B	Bridge (short-circuit) to B03
Notes B = bidirectional, GND = ground, I = input.				

**Table 2-4:** SpeedSys300 ODS301 module 3-WIRE VOLTAGE connector pinouts

SpeedSys300 ODS301 3-WIRE VOLTAGE connector				
Label	Pin	Name / function	Direction	Definition
3-WIRE VOLTAGE	B05	V+	O	Electronic sensor interface: Power supply
	B06	SIG	I	Electronic sensor interface: Signal
	B07	V-	B	Electronic sensor interface: GND
	B08	IS	B	Intrinsically safe earth / GND
Notes B = bidirectional, GND = ground, I = input, O = output.				

**Table 2-5:** SpeedSys300 ODS301 module 2-WIRE CURRENT connector pinouts

SpeedSys300 ODS301 2-WIRE CURRENT connector				
Label	Pin	Name / function	Direction	Definition
2-WIRE CURRENT	B09	I+	I	Proximity sensor (current loop) interface: Power supply
	B10	I-	I	Proximity sensor (current loop) interface: GND
	B11	IS	B	Intrinsically safe earth / GND
	B12	IS	B	Intrinsically safe earth / GND
Notes B = bidirectional, BR = bridge (short-circuit), GND = ground, I = input.				

Connector pinouts (definition of terminals) for the 8 connectors on the bottom of the module are given in Table 2-6 to Table 2-13.

**Table 2-6:** SpeedSys300 ODS301 module SAFETY ANALOG / FREQ OUT connector pinouts

SpeedSys300 ODS301 SAFETY ANALOG / FREQ OUT connector				
Label	Pin	Name / function	Direction	Definition
SAFETY ANALOG / FREQ OUT	A13	MA+	B	Safety analog (4 to 20 mA current) output: +
	A14	MA-	B	Safety analog (4 to 20 mA current) output: -
	A15	FREQ+	O	Frequency output: Signal
	A16	FREQ-	B	Frequency output: GND
Notes B = bidirectional, GND = ground, O = output.				

**Table 2-7:** SpeedSys300 ODS301 module POWER PSU 1 connector pinouts

SpeedSys300 ODS301 POWER PSU 1 connector				
Label	Pin	Name / function	Direction	Definition
POWER PSU 1	A17	V+	I	Power supply 1: +
	A18	V0	B	Power supply 1: - / GND
	A19	SH	B	Shield / SH
	A20	PE	B	Protective earth / GND
Notes B = bidirectional, GND = ground, I = input.				

**Table 2-8:** SpeedSys300 ODS301 module POWER PSU 2 connector pinouts

SpeedSys300 ODS301 POWER PSU 2 connector				
Label	Pin	Name / function	Direction	Definition
POWER PSU 2	A21	V+	I	Power supply 2: +
	A22	V0	B	Power supply 2: - / GND
	A23	SH	B	Shield / SH
	A24	PE	B	Protective earth / GND
Notes B = bidirectional, GND = ground, I = input.				

**Table 2-9:** SpeedSys300 ODS301 module RELAY 3 / RELAY 4 connector pinouts

<b>SpeedSys300 ODS301 RELAY 3 / RELAY 4 connector</b>				
<b>Label</b>	<b>Pin</b>	<b>Name / function</b>	<b>Direction</b>	<b>Definition</b>
<b>RELAY 3 / RELAY 4</b>	B13	NO	B	Relay 3: Normally open (NO) contact
	B14	COM	B	Relay 3: Common (COM) contact
	B15	NO	B	Relay 4: Normally open (NO) contact
	B16	COM	B	Relay 4: Common (COM) contact
Notes B = bidirectional, COM = common, NO = normally open.				

**Table 2-10:** SpeedSys300 ODS301 module SAFETY RELAY 1 connector pinouts

<b>SpeedSys300 ODS301 SAFETY RELAY 1 connector</b>				
<b>Label</b>	<b>Pin</b>	<b>Name / function</b>	<b>Direction</b>	<b>Definition</b>
<b>SAFETY RELAY 1</b>	B17	NO1	B	Safety relay 1: Normally open (NO) contact 1
	B18	COM1	B	Safety relay 1: Common (COM) contact 1
	B19	NO2	B	Safety relay 1: Normally open (NO) contact 2
	B20	COM2	B	Safety relay 1: Common (COM) contact 2
Notes B = bidirectional, COM = common, NO = normally open.				

**Table 2-11:** SpeedSys300 ODS301 module SAFETY RELAY 2 connector pinouts

<b>SpeedSys300 ODS301 SAFETY RELAY 2 connector</b>				
<b>Label</b>	<b>Pin</b>	<b>Name / function</b>	<b>Direction</b>	<b>Definition</b>
<b>SAFETY RELAY 2</b>	B21	NO1	B	Safety relay 2: Normally open (NO) contact 1
	B22	COM1	B	Safety relay 2: Common (COM) contact 1
	B23	NO2	B	Safety relay 2: Normally open (NO) contact 2
	B24	COM2	B	Safety relay 2: Common (COM) contact 2
Notes B = bidirectional, COM = common, NO = normally open.				

**Table 2-12:** SpeedSys300 ODS301 module PROOF TEST IN / BINARY OUT connector pinouts

SpeedSys300 ODS301 PROOF TEST IN / BINARY OUT connector				
Label	Pin	Name / function	Direction	Definition
PROOF TEST IN / BINARY OUT	C13	IN	I	Proof test input: Control signal
	C14	GND	G	Proof test input GND: Reference signal
	C15	OUT	O	Binary output: Status signal
	C16	GND	G	Binary output GND: Reference signal
Notes B = bidirectional, G = ground, I = input, O = output, GND = signal ground.				

**Table 2-13:** SpeedSys300 ODS301 module MODBUS RS485 connector pinouts

SpeedSys300 ODS301 MODBUS RS485 connector				
Label	Pin	Name / function	Direction	Definition
MODBUS RS485	C17	DATA A	B	Proof test input: Control signal
	C18	DATA B	B	Proof test input GND: Reference signal
	C19	GND	G	GND: Reference signal
	C20	IE	B	Instrument earth / GND
Notes B = bidirectional, G = ground, I = input, O = output, GND = signal ground. The SpeedSys300 ODS301 module implements Modbus RS-485 half-duplex (2-wire) communications.				

## 2.2.1 Removing and inserting screw-terminal connectors

To remove a screw-terminal connector from the main body of a SpeedSys300 ODS301 module:

- 1- Push the raised tab on the front of the screw-terminal connector (which acts as a lever) away from the main body of the module to overcome the retaining force and separate the screw-terminal connector and the module (see Figure 2-6). Use enough force to separate the connector from the body of module by approximately 5 mm.
- 2- Pull the screw-terminal connector to remove it from the main body of the module.

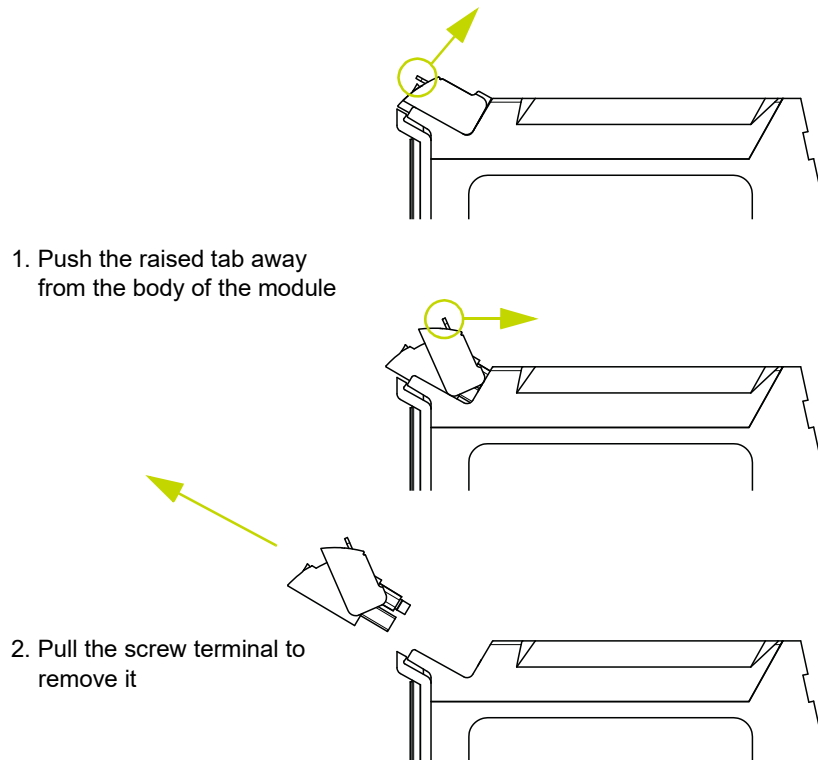

**Figure 2-6:** Removing a screw-terminal connector from the main body of a SpeedSys300 ODS301 module

To reinsert a screw-terminal connector in the body of a SpeedSys300 ODS301 module:

- 1- Ensure that the raised tab on the front of the screw-terminal connector is pushed down flat so that the rear of the connector is not obstructed.
- 2- Align the screw-terminal connector with the main body of the module, ensuring that the guide-rails of both parts are aligned, and push the connector into the main body of the module.
- 3- When the screw-terminal connector is approximately 1-2 mm from the main body of the module, more force is required to overcome the mechanical locking mechanism and the friction of the connectors.

There should be an audible click when the connector is properly inserted.

---

**NOTE:** The module's housing and connectors use mechanical key-coding to prevent incorrect connector insertion, for a system that is simple to operate and use.

---

THIS PAGE INTENTIONALLY LEFT BLANK

## 3 INSTALLATION OF A SPEEDSYS300 ODS301

This section provides an overview of the installation of SpeedSys300 ODS301 modules (SpeedSys300 ODS301 overspeed detection system) hardware. This includes module details such as mounting, grounding and important safety-related information.

### 3.1 Module details

As shown in Figure 2-1, the front panel of the SpeedSys300 ODS301 module identifies the module and its connectors, LEDs, and the USB configuration port.

The front panel of the SpeedSys300 ODS301 module identifies the function of each connector and each connector's pinout. See 2.2 SpeedSys300 ODS301 module connectors and Figure 2-1.

LEDs on the front panel of the SpeedSys300 ODS301 module are used to indicate the status and behaviour of the input signals to the module and the module itself. See 2.1 SpeedSys300 ODS301 module LEDs.

The Power LED indicates if the module has booted correctly and is operating normally (see Table 2-1).

### 3.2 Installing a module

The SpeedSys300 ODS301 module's housing features a DIN-rail mounting adaptor that allows it to be mounted directly on a DIN rail. Accordingly, SpeedSys300 ODS301 overspeed detection systems are typically housed in an industrial housing (field cabinet) with a DIN rail.

The SpeedSys300 ODS301 module's housing also features removable screw-terminal connectors that can be unplugged from the main body of the housing to simplify installation and mounting.

#### 3.2.1 Mounting procedure

A SpeedSys300 ODS301 module is typically mounted on a DIN rail in an industrial housing, rack or cabinet/cubicle installed in a vibration-free location.

---

**NOTE:** The SpeedSys300 ODS301 module has a protection rating of IP20 (in accordance with IEC 60529) and is suitable for indoor use only unless it is installed in an industrial housing or enclosure that ensures a higher level of environmental protection.

---



**The SpeedSys300 ODS301 module contains components that can be damaged or destroyed by electrostatic discharge.**

**Operating personnel should remember to observe the handling precautions mentioned in Handling precautions for electrostatic sensitive devices on page xii when handling modules and observe the necessary safety precautions against electrostatic discharge (ESD) according to EN 61340-5-1 and EN 61340-5-2.**

**Failure to do this may result in modules/cards becoming damaged by electrostatic discharges.**

A SpeedSys300 ODS301 module is easily mounted on or removed from a DIN rail (no special tools are required).

### 3.2.1.1 Mounting on a DIN rail

As shown in Figure 3-1 (left), to install a SpeedSys300 ODS301 module on a DIN rail:

- 1- Hook the non-spring-loaded end of the module's DIN-rail mounting adaptor (top) onto one edge of the DIN rail (top).
- 2- Push against the spring-loaded end of the module's DIN-rail mounting adaptor (bottom) thereby compressing the springs, while pivoting the module in order to hook the opposite end of the mounting adaptor over the other edge of the DIN rail (bottom).

### 3.2.1.2 Removing from a DIN rail

As shown in Figure 3-1 (left), to remove a SpeedSys300 ODS301 from a DIN rail:

- 1- Use a slotted screwdriver or equivalent tool to pull down the spring-loaded end of the module's DIN-rail mounting adaptor (bottom) while pivoting the module in order to unhook this end of the mounting adaptor from one edge of the DIN rail (bottom).
- 2- Unhook the opposite non-spring-loaded end of the module's DIN-rail mounting adaptor (top) from the edge of the DIN rail (top).

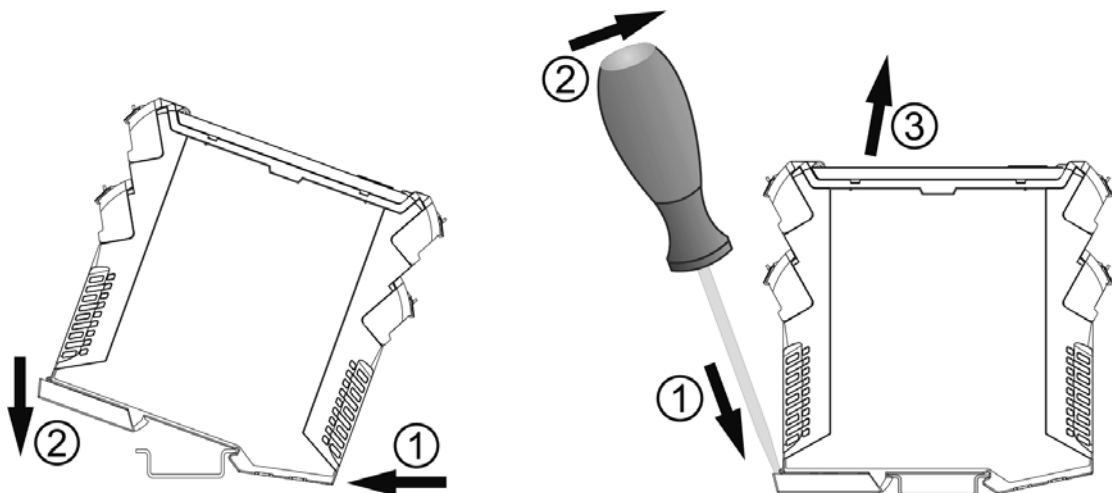

**Figure 3-1:** Mounting (left) and removing (right) a SpeedSys300 ODS301 module on/from a DIN rail

## 3.3 Installation considerations

### 3.3.1 Ventilation

SpeedSys300 ODS301 modules do not contain any ventilation units (fans). They therefore rely on either natural ventilation (convection) or forced ventilation by fans in the cabinet for their cooling. All require the free flow of air in an upward direction, with air entering the module through the vents in the base of the module and leaving it through the vents on the top of the module.

When SpeedSys300 ODS301 modules are installed in a cabinet or enclosure in which natural ventilation is used, a space of at least 50 mm should be present above and below each module, and a space of at least 10 mm should be present on both sides of each module, and a space of at least 20 mm should be present to the front of each module (see Figure 3-2).



**Always observe the minimum mounting distances around SpeedSys300 ODS301 modules in order to ensure adequate spacing is provided to allow for sufficient cooling.**

**Failure to adhere to this requirement could cause overheating, which as a consequence could affect the correct operation of the system.**

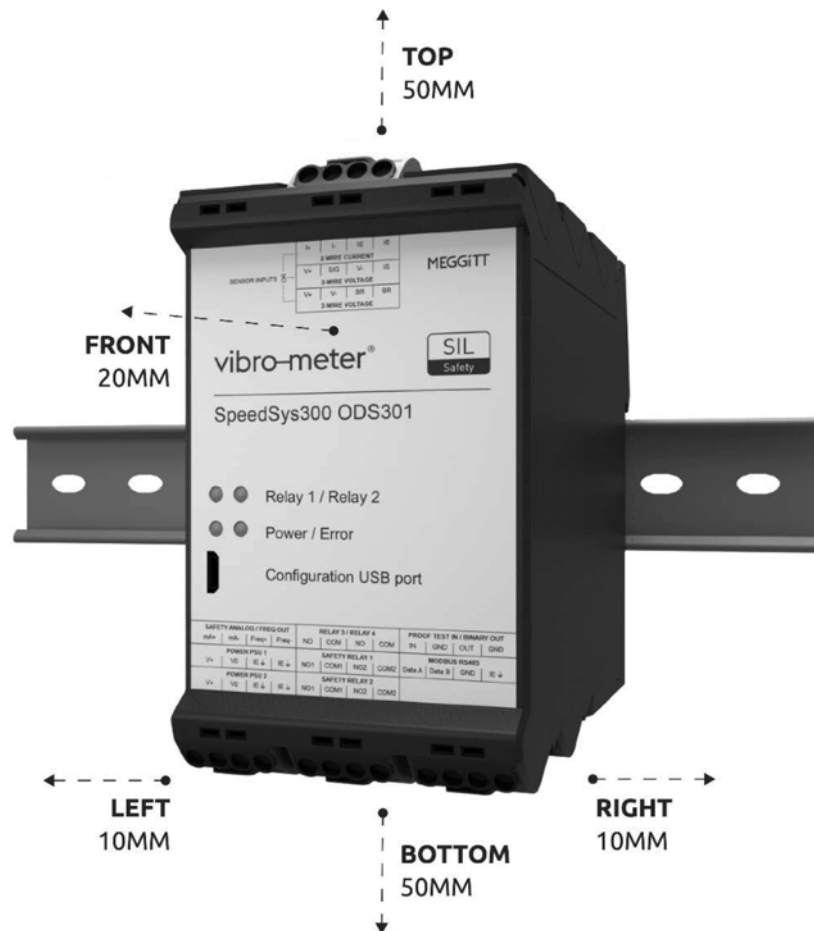

**Figure 3-2:** Minimum required spacing for a SpeedSys300 ODS301 module in an enclosure using natural ventilation

### 3.3.2 Power supply wiring

The SpeedSys300 ODS301 module has two separate +24 V<sub>DC</sub> power supply inputs (PSU 1 and PSU 2) to support external power supply redundancy for improved system availability (see Table 2-7 and Table 2-8).

### 3.3.3 Grounding

The SpeedSys300 ODS301 module requires functional grounding in order to avoid potential ground noise and EMI effects that can cause unfavourable operating conditions.

Each SpeedSys300 module must be grounded through the instrument earth connections on the power supply connectors (see Table 2-7 and Table 2-8) and grounded through the intrinsically safe earth connectors at the sensor / measurement chain input connection (see Table 2-3 to Table 2-5).

All connections must be installed with shielded cables. Connect all cable shields in the non-explosive area to instrument earth at both sides of the cable.

In case of the 2-wire current sensor (proximity sensor) or 3-wire voltage sensor (electronic sensor), the sensor cable shield has to be connected to intrinsically safe earth at the module side. If disturbances occur and inductive interferences need to be reduced, both sides of the sensor cable shield can be connected to intrinsically safe earth. However, it is important to observe the general installation regulations for explosion protection (see 3.3.6 Installations in hazardous areas).

In case of the 2-wire voltage sensor (magnetic sensor), the module requires an installation in a controlled electromagnetic environment with the grounding of the sensor cable shield at the module side. Otherwise, both sides of the sensor cable shield must be connected to intrinsically safe earth.

A wiring diagram illustrating the required sensor grounding is shown in 3.3.7 Wiring diagram. See also 3.3.6 Installations in hazardous areas.

### 3.3.4 Voting logic

To help ensure extra safety for and/or availability of rotating machinery, SpeedSys300 ODS301 modules can be combined to create different external voting logic structures, as required.

More specifically, the SIL 2 design of the SpeedSys300 ODS301 module is SIL 3 capable when used in a redundant 2oo3 architecture. To implement the 2oo3 voting logic required by SIL 3 safety applications, the safety relay outputs from three SpeedSys300 ODS301 modules can either be wired directly together or they can be connected to an external system such as a safety PLC so that the required logic is evaluated before initiating a shutdown (“trip”) of a machine.

For example, a SIL 3 overspeed solution for gas turbines uses 3 × SpeedSys300 ODS301 modules configured with external 2oo3 voting logic.

It is important to note that hardwiring the voting logic structure by wiring SpeedSys300 ODS301 module safety relays directly together avoids the introduction of interposing relays or tailing PLCs, which would inevitably add failure modes to the whole chain, negatively affecting the calculations for the SIL safety level and therefore the overall reliability.

For SIL safety loops, the use of the safety relays – relay 1 and relay 2 – is mandatory.

While technically, it is possible to use the additional (non-safety) relays – relay 3 and relay 4 – for 1oo2 and 2oo2 voting structures, these are not SIL rated. Accordingly, voting logic configurations involving the non-safety relays are covered further in this manual and are at the user’s discretion.

It is not recommended to mix differently numbered relays in one voting structure.

The below voting structure designations are regarded from a safety point of view.

### 3.3.4.1 1oo2 voting

With a 1oo2 voting logic structure, two devices/relays are connected in series such that a 1oo2 signal is given if one of the devices switches its relay (see Figure 3-3).

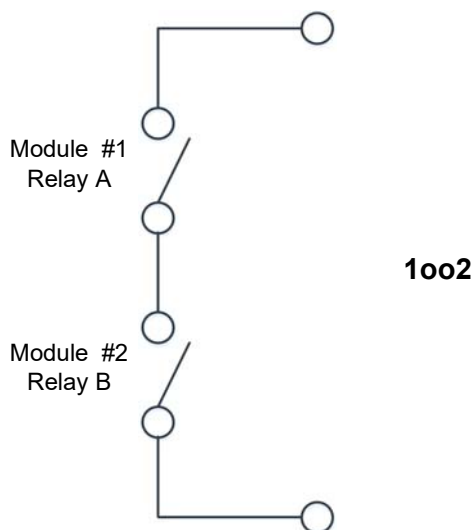

**Figure 3-3:** 1oo2 voting – relay connections

Accordingly, to obtain a 1oo2 voting logic structure, the safety relays from two SpeedSys300 ODS301 modules should be connected (hardwired) together in series, as shown in Figure 3-3.

Figure 3-4 provides an example of how to hardwire safety relay 1 of two SpeedSys300 ODS301 modules to obtain a 1oo2 voting logic structure.

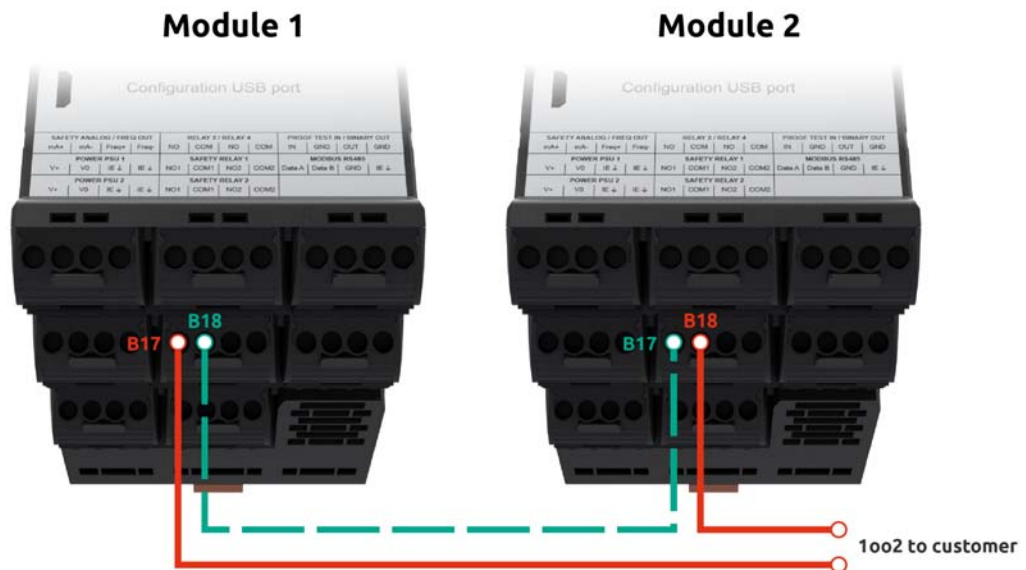

**Figure 3-4:** 1oo2 – example using safety relay 1 of SpeedSys300 ODS301 modules

Because a SpeedSys300 ODS301 module’s safety relays – relay 1 and relay 2 – are double-pole single-throw (DPST) relays, there are several ways in which two modules can be hardwired in series to obtain a 1oo2 voting logic structure.

Table 3-1 and Table 3-2 illustrate the two different ways in which a 1oo2 voting logic structure can be implemented using the safety relay 1 of two SpeedSys300 ODS301 modules.

**Table 3-1:** 1oo2 – using safety relay 1 of SpeedSys300 ODS301 modules (1)

SpeedSys300 ODS301 modules				1oo2 to customer
#1		#2		
B17		↔		1oo2 connection to customer circuit
B18	↔	B17		
		B18	↔	1oo2 connection to customer circuit

**Table 3-2:** 1oo2 – using safety relay 1 of SpeedSys300 ODS301 modules (2)

SpeedSys300 ODS301 modules				1oo2 to customer
#1		#2		
B19			↔	1oo2 connection to customer circuit
B20	↔	B19		
		B20	↔	1oo2 connection to customer circuit

Table 3-3 and Table 3-4 illustrate the two different ways in which a 1oo2 voting logic structure can be implemented using the safety relay 2 of two SpeedSys300 ODS301 modules.

**Table 3-3:** 1oo2 – using safety relay 2 of SpeedSys300 ODS301 modules (1)

SpeedSys300 ODS301 modules				1oo2 to customer
#1		#2		
B21			↔	1oo2 connection to customer circuit
B22	↔	B21		
		B22	↔	1oo2 connection to customer circuit

**Table 3-4:** 1oo2 – using safety relay 2 of SpeedSys300 ODS301 modules (2)

SpeedSys300 ODS301 modules				1oo2 to customer
#1		#2		
B23			↔	1oo2 connection to customer circuit
B24	↔	B23		
		B24	↔	1oo2 connection to customer circuit

**3.3.4.2 2oo2 voting**

With a 2oo2 voting logic structure, two devices/relays are connected in parallel such that a 2oo2 signal is given if both devices switch their relays (see Figure 3-5).

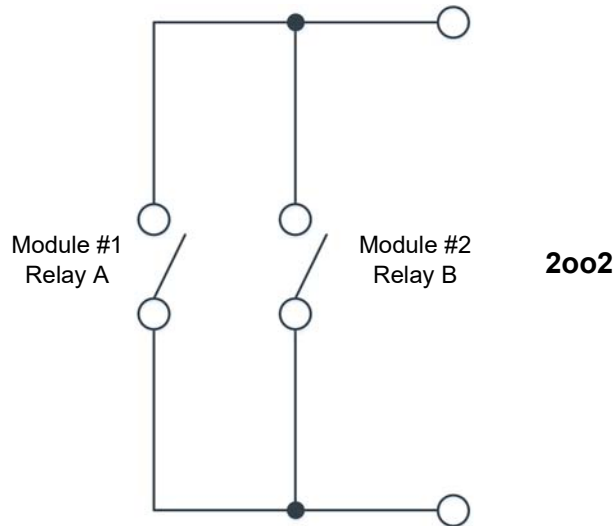

**Figure 3-5:** 2oo2 voting – relay connections

Accordingly, to obtain a 2oo2 voting logic structure, the safety relays from two SpeedSys300 ODS301 modules should be connected (hardwired) together in parallel, as shown in Figure 3-5.

Figure 3-6 provides an example of how to hardwire safety relay 1 of two SpeedSys300 ODS301 modules to obtain a 2oo2 voting logic structure.

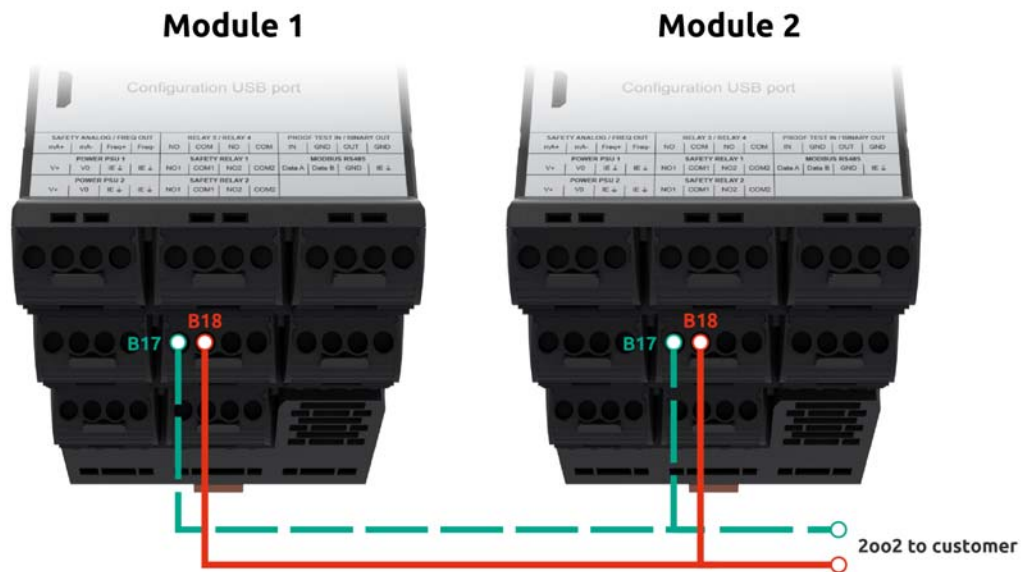

**Figure 3-6:** 2oo2 – example using safety relay 1 of SpeedSys300 ODS301 modules

Because a SpeedSys300 ODS301 module's safety relays – relay 1 and relay 2 – are double-pole single-throw (DPST) relays, there are several ways in which two modules can be hardwired in parallel to obtain a 2oo2 voting logic structure.

Table 3-5 and Table 3-6 illustrate the two different ways in which a 2oo2 voting logic structure can be implemented using the safety relay 1 of two SpeedSys300 ODS301 modules.

**Table 3-5:** 2oo2 – using safety relay 1 of SpeedSys300 ODS301 modules (1)

SpeedSys300 ODS301 modules				2oo2 to customer
#1		#2		
B17	↔	B17	↔	2oo2 connection to customer circuit
B18	↔	B18	↔	2oo2 connection to customer circuit

**Table 3-6:** 2oo2 – using safety relay 1 of SpeedSys300 ODS301 modules (2)

SpeedSys300 ODS301 modules				2oo2 to customer
#1		#2		
B19	↔	B19	↔	2oo2 connection to customer circuit
B20	↔	B20	↔	2oo2 connection to customer circuit

Table 3-7 and Table 3-8 illustrate the two different ways in which a 2oo2 voting logic structure can be implemented using the safety relay 2 of two SpeedSys300 ODS301 modules.

**Table 3-7: 2oo2 – using safety relay 2 of SpeedSys300 ODS301 modules (1)**

SpeedSys300 ODS301 modules					2oo2 to customer
#1		#2			
B21	↔	B21	↔		2oo2 connection to customer circuit
B22	↔	B22	↔		2oo2 connection to customer circuit

**Table 3-8: 2oo2 – using safety relay 2 of SpeedSys300 ODS301 modules (2)**

SpeedSys300 ODS301 modules					2oo2 to customer
#1		#2			
B23	↔	B23	↔		2oo2 connection to customer circuit
B24	↔	B24	↔		2oo2 connection to customer circuit

**3.3.4.3 2oo3 voting**

With a 2oo3 voting logic structure, three devices/relays are connected in combination such that a 2oo3 signal is given if two out of three devices switch their relays (see Figure 3-7).

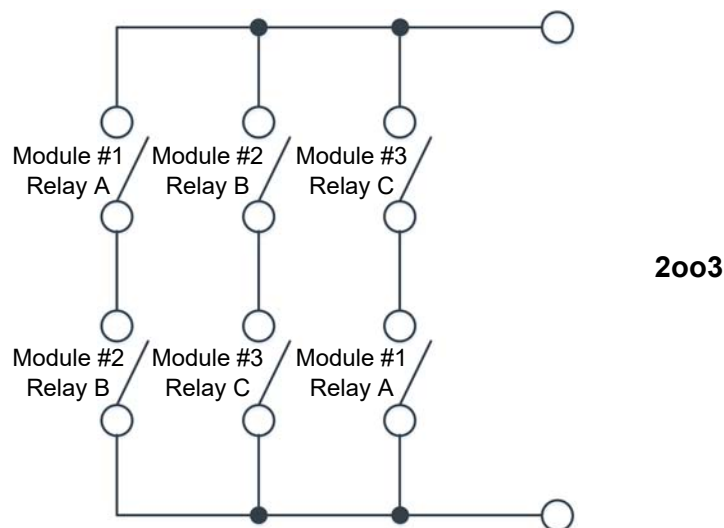

**Figure 3-7: 2oo3 voting – relay connections**

Accordingly, to obtain a 2oo3 voting logic structure, the safety relays from three SpeedSys300 ODS301 modules should be connected (hardwired) together in combination, as shown in Figure 3-7.

Figure 3-8 provides an example of how to hardwire safety relay 1 of three SpeedSys300 ODS301 modules to obtain a 2oo3 voting logic structure.

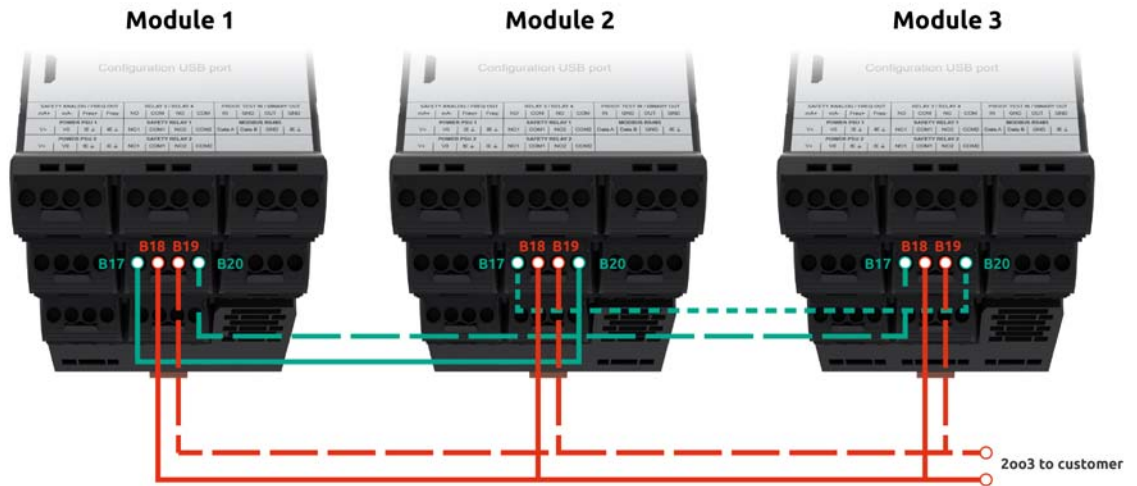

**Figure 3-8:** 2oo3 – example using safety relay 1 of SpeedSys300 ODS301 modules

Because a SpeedSys300 ODS301 module’s safety relays – relay 1 and relay 2 – are double-pole single-throw (DPST) relays, there are several ways in which three modules can be hardwired in combination to obtain a 2oo3 voting logic structure.

Table 3-9 illustrates the way in which a 2oo3 voting logic structure can be implemented using the safety relay 1 of three SpeedSys300 ODS301 modules.

**Table 3-9:** 2oo3 – using safety relay 1 of SpeedSys300 ODS301 modules

SpeedSys300 ODS301 modules						2oo3 to customer
#1		#2		#3		
B17	↔	B20				
		B17	↔	B20		
B20		↔		B17		
B18	↔	B18	↔	B18	↔	2oo3 connection to customer circuit
B19	↔	B19	↔	B19	↔	2oo3 connection to customer circuit

Table 3-10 illustrates the way in which a 2oo3 voting logic structure can be implemented using the safety relay 2 of three SpeedSys300 ODS301 modules.

**Table 3-10:** 2oo3 – using safety relay 2 of SpeedSys300 ODS301 modules

SpeedSys300 ODS301 modules						2oo3 to customer
#1		#2		#3		
B21	↔	B24				
		B21	↔	B24		
B24	↔			B21		
B18	↔	B18	↔	B18	↔	2oo3 connection to customer circuit
B19	↔	B19	↔	B19	↔	2oo3 connection to customer circuit

### 3.3.5 Electrical connections

For the SpeedSys300 ODS301 module, electrical connections are established via removable screw-terminal connectors. Each connector (entire pluggable terminal block), containing four clamps/contacts can be removed by pushing against the connector tab (see 2.2.1 Removing and inserting screw-terminal connectors).

A matching screwdriver should be used to loosen and tighten the screws before and after inserting the wire into the clamps/contacts of each connector.

The module's housing and connectors use mechanical key-coding to prevent incorrect connector insertion, for a system that is simple to operate and use.

A wiring diagram illustrating the required sensor grounding is shown in 3.3.7 Wiring diagram.

### 3.3.6 Installations in hazardous areas

SpeedSys300 ODS301 module's sensor / input channel interfaces (proximity, electronic and magnetic) are galvanically separated in order to allow a direct connection to a sensor / measurement chain installed in a potentially explosive atmosphere (hazardous area), eliminating the need for additional external safety barriers such as Zeners.

To support installations in hazardous areas, the SpeedSys300 ODS301 module's connectors can be divided into two groups:

- Ex connectors, located on the top of the module.

---

**NOTE:** The SpeedSys300 ODS301 module's Ex connectors are identifiable by their blue colour.

---

- Non-Ex connectors, located on the bottom of the module.

See also 2.2 SpeedSys300 ODS301 module connectors.

In applications where a SpeedSys300 ODS301 module is connected to circuitry (sensor / measurement chain) installed in a potentially explosive atmosphere, it is the user's responsibility to ensure that the general installation regulations for explosion protection in accordance with EN 60079-14 and the applicable safety directives are all observed.

See also 3.3.3 Grounding and 3.3.9 Safety instructions – potentially explosive atmospheres.

### 3.3.7 Wiring diagram

Figure 3-9 shows the electrical interfaces for the product.

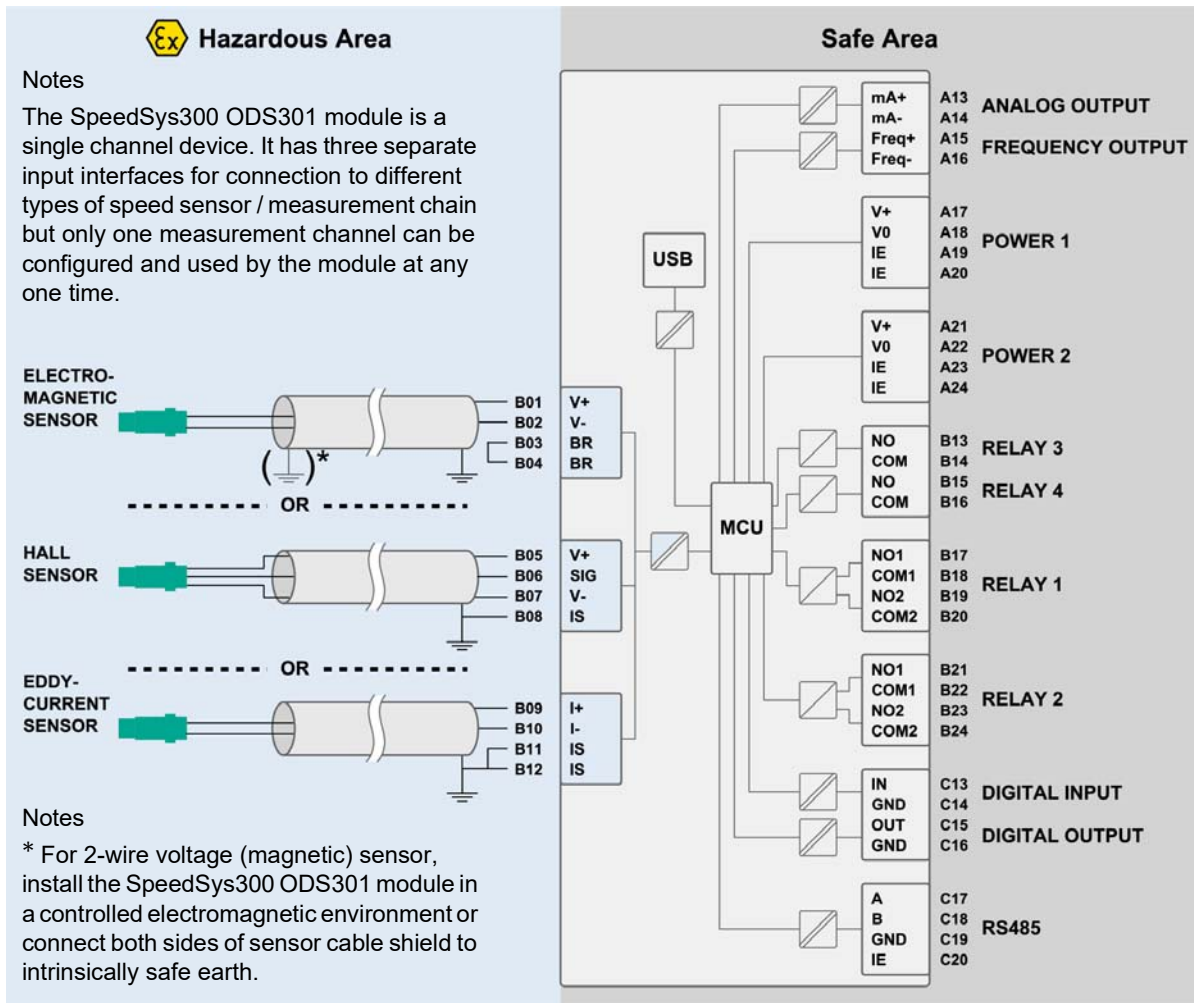

**Figure 3-9:** SpeedSys300 ODS301 module wiring diagram

The sensor / input channel interfaces (proximity, electronic and magnetic) on the left side of Figure 3-9 are short circuit proof.

(See also Figure 1-2 for more detailed information on all of the SpeedSys300 ODS301 module’s hardware interfaces.)



**As shown in Figure 3-9, the use of a 2-wire voltage sensor (magnetic sensor) requires a bridge (short-circuit) to be set between the BR contacts of the 2-WIRE VOLTAGE connector (see Table 2-3). In case of the 2-wire voltage (magnetic) sensor not being used, the bridge must be removed in order to ensure full functionality of the module.**



**Refer to the *SpeedSys300 ODS301 overspeed detection system data sheet* for further information before connecting any electrical interfaces.**



### 3.3.8 Safety instructions – safety-related applications

For use in safety-related applications (functional-safety contexts), the SpeedSys300 ODS301 module is equipped with two processors (microcontrollers) that mutually monitor each other (the “Duotec” system).

For all information and installation instructions concerning applications (functional-safety contexts), refer to the *SpeedSys300 ODS301 overspeed detection system safety manual (pending)*.

### 3.3.9 Safety instructions – potentially explosive atmospheres

For use in applications where a SpeedSys300 ODS301 module is connected to circuitry (sensor / measurement chain) installed in a potentially explosive atmosphere (hazardous area), the SpeedSys300 ODS301 module has the following explosion protection marking:

-  II (1) G [Ex ia Ga] IIC (outside Ex Zone)
-  II (1) D [Ex ia Da] III

#### 3.3.9.1 Category (1) G equipment

As a certified category (1) G equipment, the device may only be mounted in the ex-safe (non-hazardous) area. The protected sensor circuits (B01-B02, B05-B06-B07 or B09-B10) may reach into areas, requiring 1G, 2G or 3G equipment.

#### 3.3.9.2 Category (1) D equipment

As a certified category (1) D equipment, the device may only be mounted in the ex-safe (non-hazardous) area. The protected sensor circuits (B01-B02, B05-B06-B07 or B09-B10) may reach into areas, requiring 1D, 2D or 3D equipment.



**AS AN ASSOCIATED APPARATUS, THE SPEEDSYS300 ODS301 MODULE MUST BE INSTALLED OUTSIDE OF THE POTENTIALLY EXPLOSIVE AREA.**



**IF A SPEEDSYS300 ODS301 MODULE IS CONNECTED TO CIRCUITS ENTERING A POTENTIALLY EXPLOSIVE AREA, THE GENERAL INSTALLATION REGULATIONS FOR EXPLOSION PROTECTION EN 60079-14, THE APPLICABLE SAFETY DIRECTIVES, AND THE INSTRUCTIONS OF THIS USER MANUAL AND SAFETY MANUAL MUST BE OBSERVED.**

**SPECIFICALLY, ATTENTION MUST BE PAID TO STRICT COMPLIANCE WITH THE AMBIENT CONDITIONS AND CONNECTION PARAMETERS, AS WELL AS THE RECOMMENDATIONS ON INSTALLATION AND GROUNDING.**

**ONLY ONE SENSOR IS ALLOWED TO BE CONNECTED TO A SPEEDSYS300 ODS301 MODULE AT ANY ONE TIME.**

**THE INSTALLATION OF SYSTEMS FOR USE IN POTENTIALLY EXPLOSIVE ATMOSPHERES (HAZARDOUS AREAS) MUST ALWAYS BE CARRIED OUT BY QUALIFIED PERSONNEL.**



**WHEN CARRYING OUT MEASUREMENTS ON THE INTRINSICALLY SAFE SIDE, BE SURE TO OBSERVE THE RELEVANT REGULATIONS REGARDING THE CONNECTION OF INTRINSICALLY SAFE EQUIPMENT.**

**ONLY USE DEVICES AND EQUIPMENT APPROVED FOR USE IN INTRINSICALLY SAFE CIRCUITS.**

THIS PAGE INTENTIONALLY LEFT BLANK

## 4 CONFIGURATION OF A SPEEDSYS300 ODS301

This section provides an overview of the SpeedSys300 software that is used for the configuration, operation and management of SpeedSys300 ODS301 overspeed detection systems.

### 4.1 Software

SpeedSys300 is proprietary software from Meggitt vibro-meter® for the configuration, operation and management of overspeed detection and protection systems using SpeedSys300 ODS301 modules.

#### 4.1.1 Software versions

The latest version of the SpeedSys300 software is version 1.00 (April 2021).

Contact your local Meggitt representative or Meggitt SA for the latest version of the software.

#### 4.1.2 Computer system requirements

The SpeedSys300 software will run on most modern, up-to-date Windows® computers.

The main computer system requirements are:

- 64-bit (or 32-bit) Microsoft® Windows operating systems such as Windows 10, Windows 8.1 or Windows 7.

---

**NOTE:** Windows 7 is not recommended for new installations as Microsoft support for Windows 7 ended in January 2020.

---

- USB port with USB Type-A connector.

### 4.2 Software installation

The SpeedSys300 software is not “installed software” and can be used on most Windows® computers by simply copying the required files to the computer and running the *SpeedSys300.exe* executable/program file.

---

**NOTE:** In order to run the SpeedSys300 software, the user account being used should have administrator level user rights.

For example, Windows 10 implements user account control (UAC) such that when a standard user attempts to run an app/program that requires an administrator access token, UAC requires that the user provide valid administrator credentials.

---

### 4.3 Software user interface

The SpeedSys300 software user interface consists of a single main window with a multiple window tabbed document interface that provides the controls for configuring, operating and managing SpeedSys300 ODS301 modules (see Figure 4-1 and Figure 4-3).

Looking from top to bottom and left to right, the SpeedSys300 user interface consists of a title bar, a menu bar, a series of tabbed windows (left) and an overall module information and controls window (right).

The series of tabbed windows (left) are Device, Measurement, Output, Diagnostics, Process data, Device status, Report and Event log.

## 4.4 Getting started

The SpeedSys300 software automatically detects the SpeedSys300 ODS301 module connected to the computer running the software, so it is recommended that the module is connected to the computer and that the power supply to the module is on before starting the SpeedSys300 software:

- 1- Connect the computer to the SpeedSys300 ODS301 module using the USB Type-A to USB Mini-B cable supplied with the module (or equivalent).

The SpeedSys300 ODS301 module's USB Mini-B connector is located on the front panel of the module.

- 2- Turn on the power supply to the SpeedSys300 ODS301 module.
- 3- Start the SpeedSys300 software, for example, by double-clicking the *SpeedSys300.exe* executable/program file.

The SpeedSys300 software's main window is displayed (see Figure 4-1).

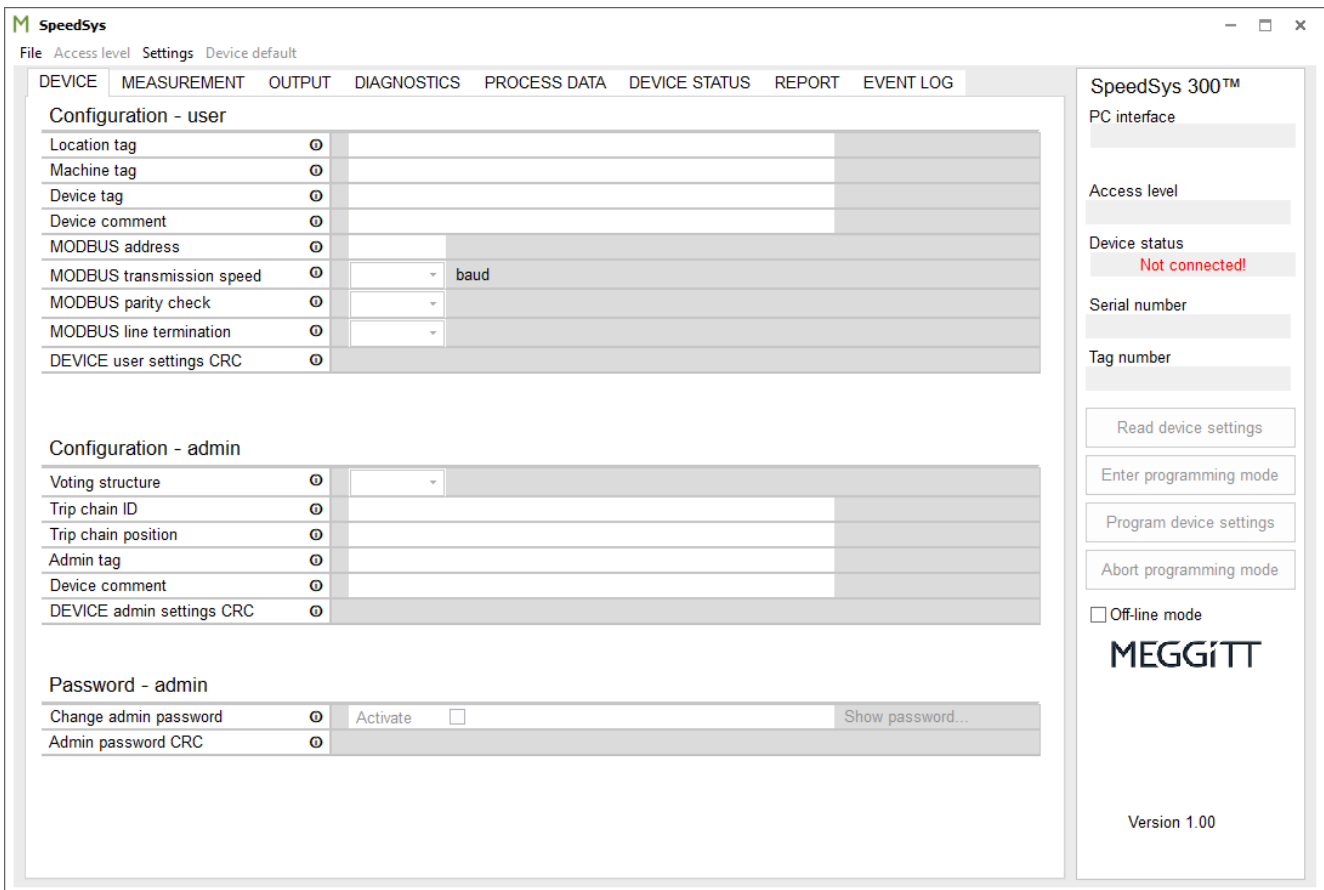

**Figure 4-1:** SpeedSys300 user interface – main window (when not connected)

Note that in Figure 4-1, the overall module information and controls window (right) does not display any useful information for the module as the USB communications is not yet configured correctly. More specifically, Device status: Not connected.

- 4- In the SpeedSys300 software, configure the USB communications interface between SpeedSys300 software and the SpeedSys300 ODS301 module.
- Click the **Settings > Interface settings** menu and use the Interface settings window that is displayed to configure the communications interface (see Figure 4-2).
- Use Serial port to select the COM port to use for USB communications with the module. The available COM ports are automatically detected when the software starts and can be manually detected using the Rescan control.
- Ensure that the USB Connection control is selected as this is always required to communicate with a SpeedSys300 ODS301 module via USB.
- (Baud rate, Parity and Modbus address are reserved for serial communications / factory use.)
- 5- When configured, click OK to continue.

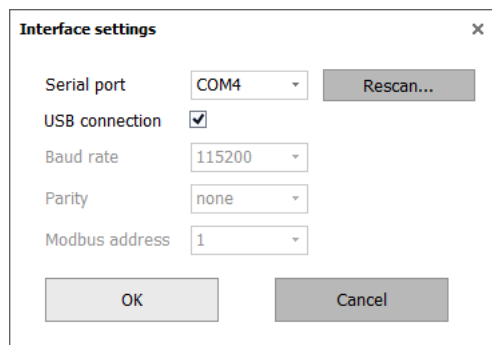

**Figure 4-2:** SpeedSys300 user interface – Interface settings

---

**NOTE:** If required, Windows Device Manager can be used to find the COM port number to use.

For example, start the Device Manager and in the main window, under Ports (COM & LPT), look for USB serial port (COMx).

If the SpeedSys300 ODS301 module is connected after the SpeedSys300 software was started, then the Rescan control in the Interface settings window may need to be used in order to see the module as a COMx port.

---

Once communications is established, the SpeedSys300 software communicates automatically with the SpeedSys300 ODS301 module to obtain high-level module information that is displayed in the overall module information and controls window (right):

- PC interface – computer interface port and settings being used.  
For example, COM4 (USB).
- Access level – user access level (permissions).  
For example, User, when first connected to a module.
- Device status – operating mode/status of the module.  
For example, Operating, during normal operation of a module.
- Serial number – unique factory-assigned serial identification number for the module.  
For example, SSY300-xxxxx.
- Tag number – user-configurable tag number used to identify the module.

Figure 4-3 shows the SpeedSys300 software’s main window when the software is connected to a SpeedSys300 ODS301 module.

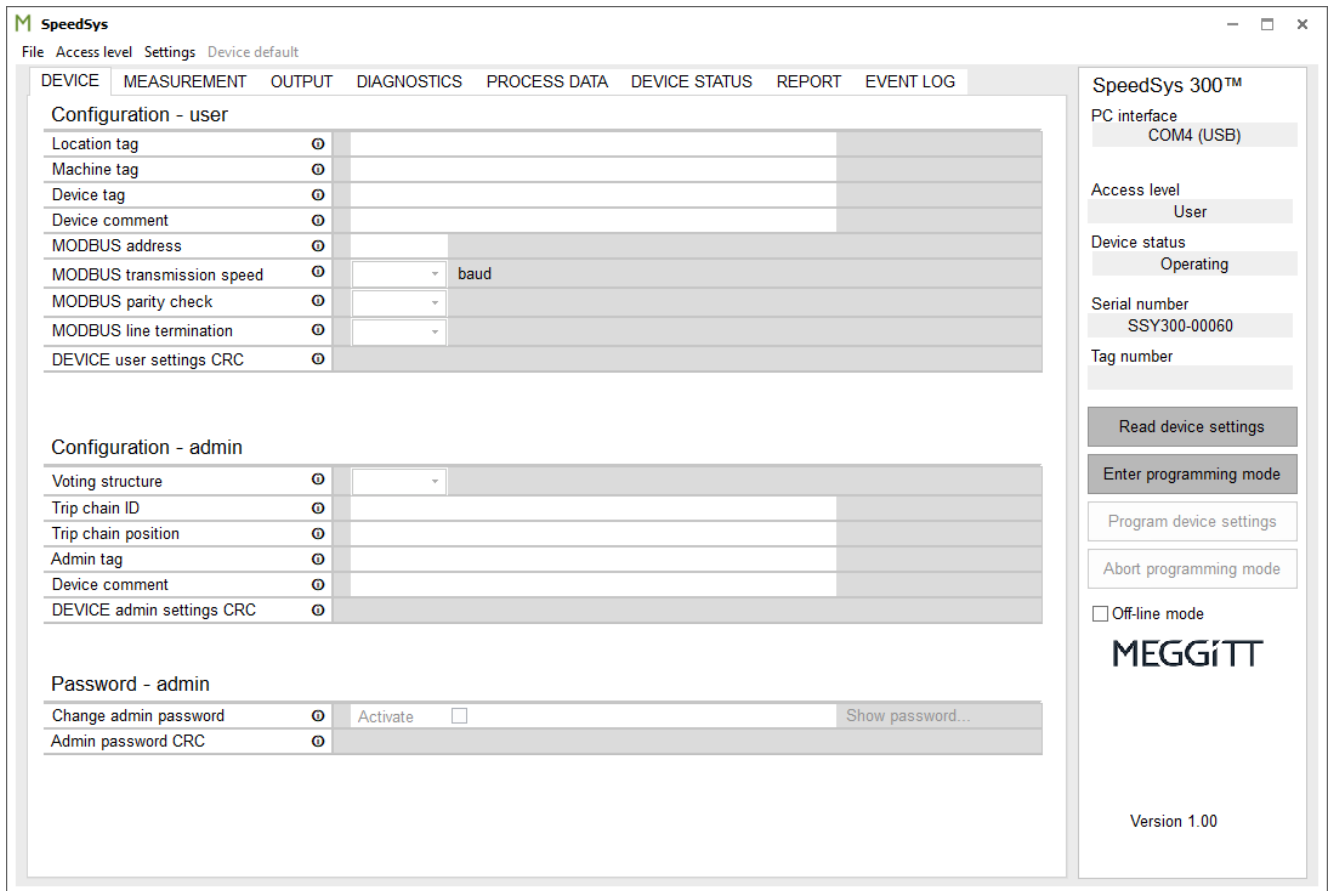

**Figure 4-3:** SpeedSys300 user interface – main window (when connected)

Note that the overall module information and controls window (right) now displays useful information for the module, such as Access level: User and Device status: Operating.

Once communications has been established between the SpeedSys300 software and the SpeedSys300 ODS301 module (for example, Device status: Operating or similar), the status of the module can be read and/or the configuration of the module can be read/written (see 4.5 Module configuration).

## 4.5 Module configuration

Once connected, the software always displays the high-level information for the connected device (module) in the overall module information and controls window (right), that is, Access level, Device status, Serial number and Tag number. In addition, the commands/operations that can be performed for the connected device (module) are also displayed and available in the overall module information and controls window. This is shown in Figure 4-3.

### 4.5.1 Reading a module's configuration

After the SpeedSys300 software has detected the connected SpeedSys300 ODS301 module, the software is ready to read the module's configuration.

In the SpeedSys300 software, in the overall module information and controls window (right), the Read device settings control is used to download the configuration from the SpeedSys300 ODS301 module to the software.

To read the configuration from the connected SpeedSys300 ODS301 module, in the SpeedSys300 software, in the overall module information and controls window (right), click the **Read device settings** control.

The SpeedSys300 software will read the configuration directly from the SpeedSys300 ODS301 module. If the configuration read from the module is different from the configuration currently displayed by the SpeedSys300 software, the user will be prompted to continue before the settings in the software are overwritten and displayed.

### 4.5.2 Loading and saving configuration files

When working with SpeedSys300 ODS301 module configurations, the SpeedSys300 software can be used to load and/or save configuration files.

---

**NOTE:** The SpeedSys300 software uses a proprietary file format with the \* .*ssy* file name extension for its configuration files.

---

In the SpeedSys300 software, the Load configuration command is used to load a SpeedSys300 ODS301 module configuration from a configuration file.

In the SpeedSys300 software, use the **File > Load configuration** menu command.

In the SpeedSys300 software, the Save configuration command is used to save a SpeedSys300 ODS301 module configuration to a configuration file.

In the SpeedSys300 software, use the **File > Save configuration** menu command.

Saving and loading SpeedSys300 ODS301 module configurations in this way allows work to be saved when developing a configuration, work to be shared when a configuration from one machine is to be used as the basis for another machine and/or when working offline (that is, without a "live" connection to a module).

### 4.5.3 Activating a configuration on a module

In order to activate a configuration on SpeedSys300 ODS301 module (that is, program the module), the Program device settings control in the overall module information and controls window (right) must be used. See 5.10 Programming parameters for further information.

#### 4.5.4 test 300.ssy configuration file

When developing configurations for SpeedSys300 ODS301 modules, the `test 300.ssy` configuration, or other known good configuration, should be used as a starting point.

The `test 300.ssy` configuration file is provided as part of the SpeedSys300 software and should be available in the same folder as the `SpeedSys300.exe` executable/program file (see 4.2 Software installation).

---

**NOTE:** It is not possible to create a SpeedSys300 ODS301 module configuration “from scratch” and all module configurations should be based on `test 300.ssy` or an equivalent known good configuration.

---

The **File > Load configuration** menu command is used to load (read) the `test 300.ssy` configuration into the SpeedSys300 software.

## 4.6 Access levels/permissions

It is important to note that the SpeedSys300 ODS301 module and SpeedSys300 software implement a system of access levels to control and limit the functionality of the module/software that are available to different users (with different access levels).

There are two categories of access level (user), as follows:

- User

The User category provides basic access/permission.

This access level allows some of the configuration of a module to be read and/or written, including allowing settings such as machine and device tags to be changed, as well as serial Modbus (RS-485) communication parameters such as baud rate, parity and line termination.

Note: The User access level is the default and is not password protected.

- Admin

The Admin category provides complete access/permission.

This access level allows all of the configuration of a module to be read and/or written, thereby enabling the complete configuration/reconfiguration of a module including settings such as the voting structure, trip chain and dedicated administrator tags, as well as device comments.

Note: The Admin access level is password protected.

The current user access level is displayed in the overall module information and controls window (right). For example, Access level: User (see Figure 4-3).

In the SpeedSys300 software, the Admin and User commands are used to change the access level for a SpeedSys300 ODS301 module, as required.

To change the access level from User to Admin:

- 1- In the SpeedSys300 software, click the **Access level > Admin** menu command.
- 2- When prompted, enter the password for the Admin access level.

---

**NOTE:** For a SpeedSys300 ODS301 module, the factory-assigned default password for the Admin access level is `speedsys` (one word, all lowercase).

---

- 3- After the password is correctly entered, the SpeedSys300 ODS301 module and SpeedSys300 software will change to the Admin access level. This change is displayed in the overall module information and controls window (right) with Access level: Admin.

To change the access level from Admin to User:

- 1- In the SpeedSys300 software, click the **Access level > User** menu command.
- 2- The SpeedSys300 ODS301 module and SpeedSys300 software will immediately change to the User access level (that is, no password is required). This change is displayed in the overall module information and controls window (right) with Access level: User.

#### 4.6.1 Changing the Admin access level password

For improved security, especially in deployed SpeedSys300 ODS301 overspeed detection systems, it is strongly recommend to change the default password for the Admin access level.

In the SpeedSys300 software, the Change admin password controls on the Device tab are used to change the default password for the Admin access level.

To change the default password for the Admin access level:

- 1- In the SpeedSys300 software, ensure that the current user access level is Admin (see 4.6 Access levels/permissions).

---

**NOTE:** For a SpeedSys300 ODS301 module, the current user access level must be Admin in order to change the password.

---

- 2- In the SpeedSys300 software, click the **Device** tab to display the associated parameters and commands.
- 3- On the **Device** tab, under **Password - admin**:
  - Select the **Activate** check box control in order to allow the password to be changed.
  - Type the new password into the data entry field (blank) to the right of the **Activate** check box control.

Note: Click and hold the **Show password** control to the right of the data entry field (blank) to make the password visible as entered.
- 4- In the overall module information and controls window (right), click the **Enter programming mode** control to enter the programming mode.

When prompted, click **OK** to continue.



**ENTERING THE PROGRAMMING MODE WILL FORCE THE SPEEDSYS300 ODS301 MODULE AND ITS OUTPUTS INTO THEIR SAFE STATE. ACCORDINGLY, IT IS HIGHLY RECOMMENDED THAT MODULE PROGRAMMING IS ONLY PERFORMED IN ACCORDANCE WITH THE OPERATING PROCEDURES FOR THE MACHINERY BEING MONITORED AND THAT APPROPRIATE PRECAUTIONS ARE TAKEN AT THE CONTROL SYSTEM LEVEL (SUCH AS DCS OR PLC).**

Note that the overall module information and controls window (right) updates to display Device status: Programming – safe state.

- 5- In the overall module information and controls window (right), click the **Program device settings** control to program the device settings, that is, change the password.

When prompted to proceed and overwrite existing parameters, click **OK** to continue.

---

**NOTE:** Programming the device settings will overwrite all existing parameters on the SpeedSys300 ODS301 module, including the password.  
More specifically, the module is completely reconfigured using all of the parameters configured/changed in the SpeedSys300 software – so it is important that the password is the only parameter that has been changed (if that is all that is required).

---

When prompted to commit the changes, click **OK** to continue.

After the module has been updated:

- The SpeedSys300 ODS301 module will change from the Programming – safe state mode back to the Operating mode and run using the updated parameters.
- The SpeedSys300 ODS301 and SpeedSys300 software will also change from the Admin access level back to the User access level.

The new password must be used the next time that it is required to change the access level from User to Admin.

---

**NOTE:** Please note that once the Admin access level is changed, it is the user's responsibility to manage (remember) this password, as it cannot be changed/reset remotely.  
Should the Admin access level password become lost, the only way for the SpeedSys300 ODS301 module to be "reset" is to return the module to Meggitt SA.

---

## 5 COMMISSIONING OF A SPEEDSYS300 ODS301

This section provides an overview of how to use the SpeedSys300 software for the commissioning of SpeedSys300 ODS301 overspeed detection systems.

### 5.1 Configuration parameters and settings

To create a fully functioning configuration for a SpeedSys300 ODS301 module, the SpeedSys300 software must be used to configure all of the measurement parameters and settings required for the application, then software must be used to upload (program) the configuration to the module.

---

**NOTE:** When developing configurations for SpeedSys300 ODS301 modules, the `test 300.ssy` configuration, or other known good configuration, should be used as a starting point. See 4.5.4 `test 300.ssy` configuration file.

---

In the SpeedSys300 software, the series of tabbed windows (left) in the main window of the user interface are used to configure the individual parameters as required. Simply click on a tab to select it and display its parameters.

Most parameters include a tooltip that can be used to display a short description regarding the parameter. Simply, hover the pointer over the tooltip icon (  ) to display this information.

## 5.2 Device tab

The Device tab and its parameters are shown in Figure 5-1.

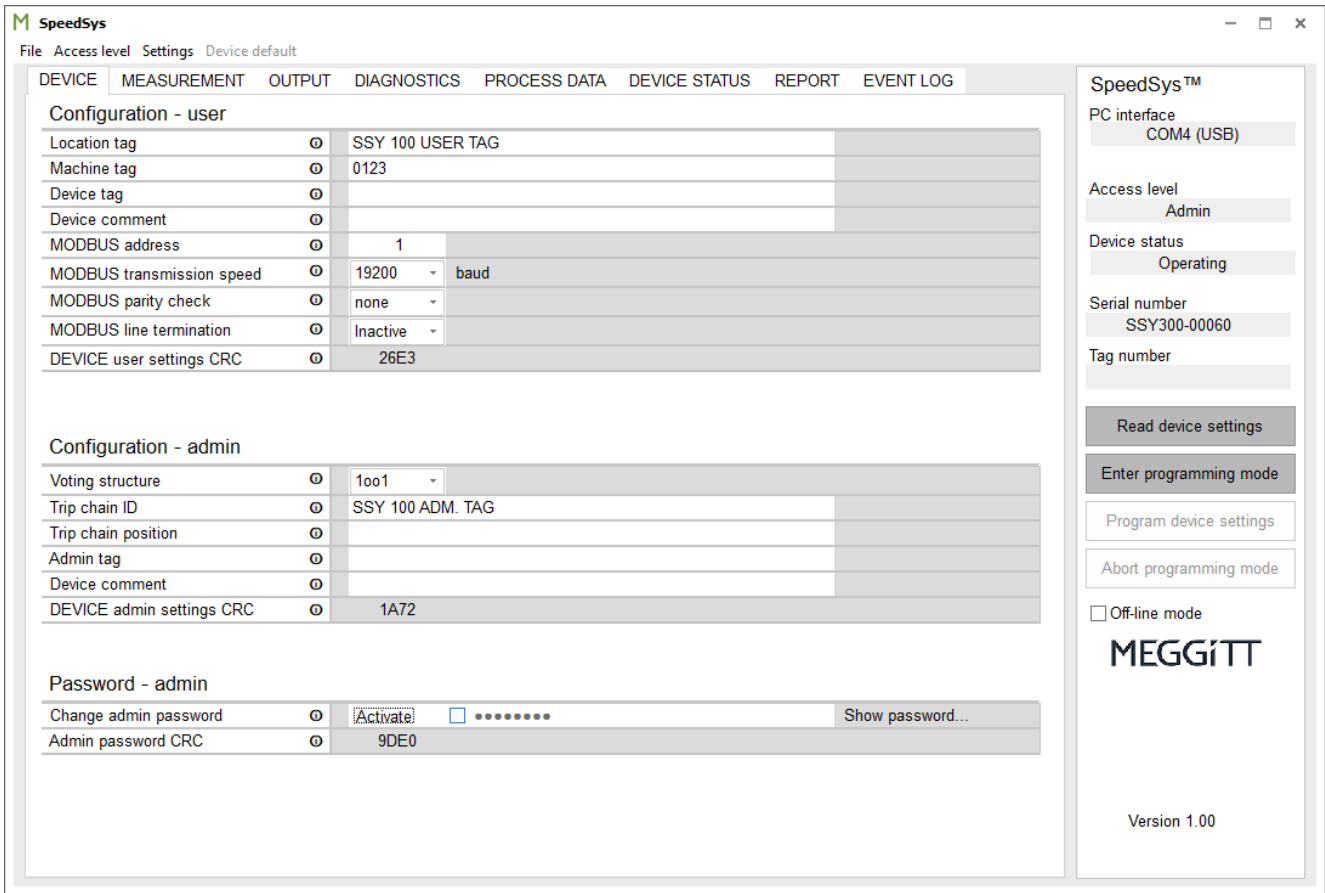

**Figure 5-1:** SpeedSys300 software – Device tab

### 5.2.1 Device tab – Configuration user

Used to configure more basic configuration information for a SpeedSys300 ODS301 module such as tag names and comments (descriptive text). That is, “User” access level information.

In addition, the MODBUS fields/parameters are used to configure the module’s Modbus RS-485 interface.

The default communication parameters for the module’s Modbus RS-485 interface are:

- Modbus address: 1
- Modbus transmission speed: 19200 baud
- Modbus parity check: None
- Modbus line termination: Inactive.

### 5.2.2 Device tab – Configuration admin

Used to configure more advanced configuration information for a SpeedSys300 ODS301 module such as Voting structure, Trip chain ID and Trip chain position. That is, “Admin” access level information.

---

**NOTE:** Under **Configuration admin**, the data entry fields (descriptive text) must be completed correctly in order to create an IEC 61511 compliant report for the SpeedSys300 ODS301 module.

This is typically required for the use of SpeedSys300 ODS301 overspeed detection systems in safety-related applications (functional-safety contexts).

---

### 5.2.3 Device tab – Password admin

- Change admin password

See 4.6.1 Changing the Admin access level password.

- Admin password CRC

Cyclic redundancy check value calculated by the SpeedSys300 software. (Such CRCs are primarily intended for use by the SpeedSys300 software and SpeedSys300 ODS301 module only.)

### 5.3 Measurement tab

The Measurement tab and its parameters are shown in Figure 5-2.

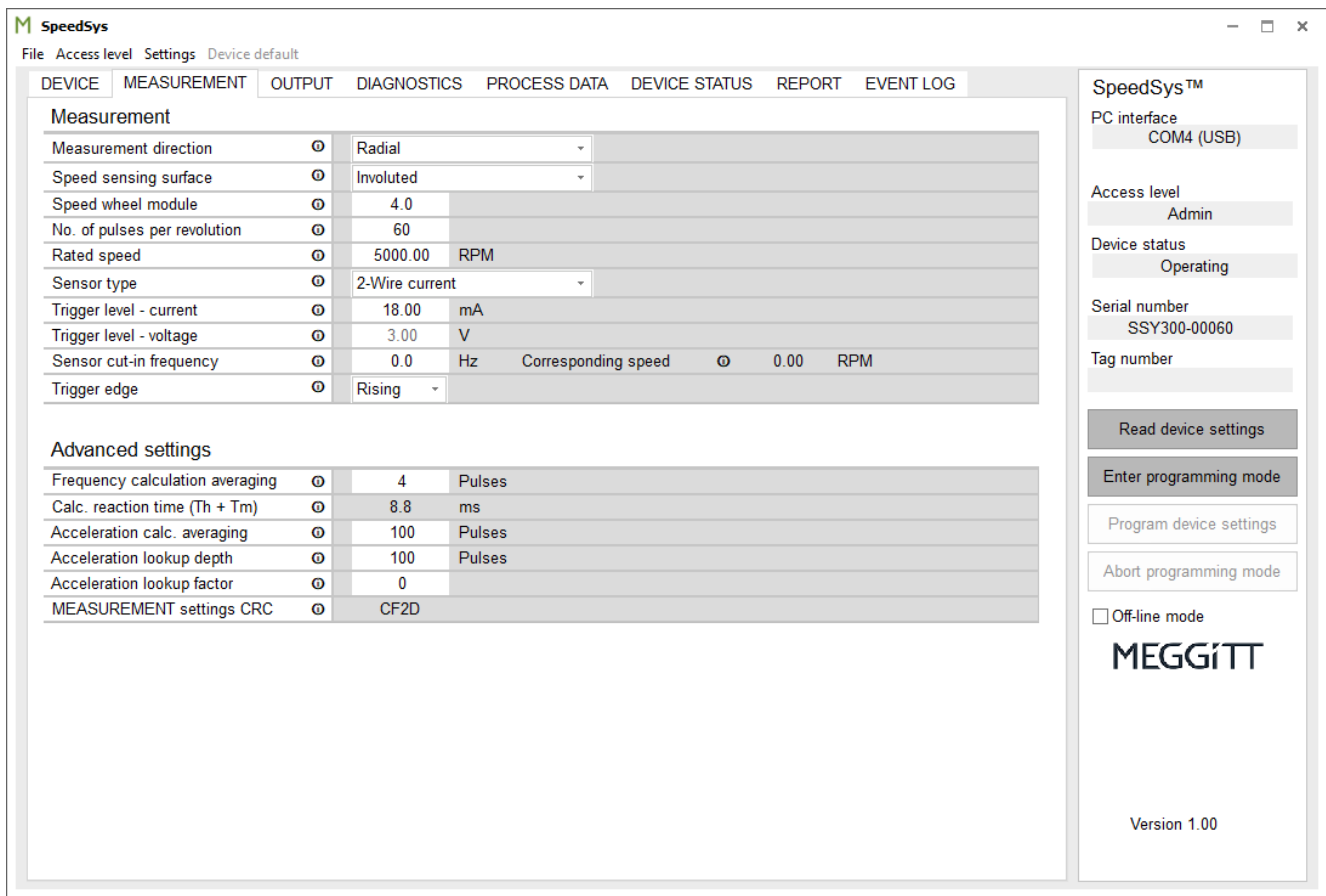

**Figure 5-2:** SpeedSys300 software – Measurement tab

#### 5.3.1 Measurement tab – Measurement

- Measurement direction

Three measurement directions can be selected: Axial, Radial or Tangential.

If Axial is selected, the sensor measures along the machine’s axis.

Selecting Radial switches to measuring perpendicular to the machine’s axis.

Tangential means measuring the axis under a certain angle.

- Speed sensing surface

Four options for the speed sensing surface are available: Involute (typical gear wheel shape), Squared (squared teeth on speed wheel), Pole band (toothed band around machine shaft) or Rounded (drilled holes which are typically located axially).

- Speed wheel module

Enter factor of speed wheel diameter divided by the number of teeth (for example, a diameter of 200 mm and 100 teeth results in a speed wheel module value of 2).

- No. of pulses per revolution

Defines how many pulses correspond to one revolution of the rotary setup. Required for correct rotational speed calculation.

- Rated speed

Defines the normal operating speed of the machine. This value affects the scaling of the graphical display on the Process data tab (see 5.6 Process data tab).

- Sensor type

The module supports three different sensor types that activate the corresponding functionality in the software upon activation.

The 2-wire current sensor type is for use with a Meggitt vibro-meter® eddy-current proximity measurement sensor / chain with a current output – such as the TQ9xx or TQ4xx series.

The 3-wire voltage sensor type is for use with powered Hall effect sensors.

The 2-wire voltage sensor type is for use with self-generating inductive sensors such as variable reluctance (VR) or electromagnetic probes (MPU).

(The input voltage ranges from 20 mV<sub>RMS</sub> to 80 V<sub>RMS</sub>.)

- Trigger level – current / voltage

Configures the pulse detection threshold for the input signal (current or voltage). Above the threshold, a signal is assumed to be a pulse.

For current sensor types, this corresponds to the 2-wire current input (2-wire: 18 mA by default).

For voltage sensor types, this corresponds to the 3-wire and 2-wire voltage inputs (3-wire: 3 V by default; 2-wire: best engineering practice).

- Sensor cut-in frequency

Defines a lower frequency limit for a reliable sensor signal. Below this limit the evaluated speed and acceleration are assumed and output as 0, and no bad pulse evaluation is performed.

- Trigger edge

Defines the trigger type as either the rising or falling edge of the input signal.

### 5.3.2 Measurement tab – Advanced settings

- Frequency calculation averaging

Number of pulses to be used for the calculation of the moving average of the frequency.

- Calc. reaction time (  $Th + Tm$  )

If on the Output tab, a delay uses a value other than 0, they add to the total reaction time less the calculated reaction time.

Hardware reaction time ( $Th$ ) is a fixed value of 8 ms.

Measurement reaction time ( $Tm$ ) is automatically optimised by the module based on configuration parameters such as the number of teeth, rated speed and frequency averaging.

- Acceleration calc. averaging

Number of pulses to be used for the calculation of the moving average of the frequency, which is strictly used for acceleration calculation.

- Acceleration lookup depth

The acceleration value is evaluated from two frequency values and their timestamps. For evaluation, the last frequency and one of the previous is considered. Which of the previous values is to be considered is determined by the user in the measurement configuration parameters as the “acceleration lookup depth”. This parameter can be set between 1 and 5000.

The acceleration is calculated by dividing a frequency difference by the time that has passed. The difference is calculated from averaged frequencies (see the image below). The time between the two frequency averaging periods is defined by the depth-parameter (as it is given as a number of pulses, the actual time is frequency dependent).

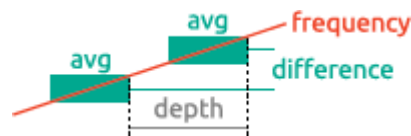

- Acceleration lookup factor

The lookup factor can be used for a dynamic lookup depth. If the lookup factor is used, the lookup depth is calculated by the ratio of the measured frequency and the specified lookup factor, as described in the following formula:

$$D_f = f_n / x_{lookup}$$

Where

$D_f$  : Lookup depth calculated from depth factor. Lower limit is 1, upper limit is the fixed acceleration lookup depth parameter.

$f_n$  : Frequency evaluated for pulse n.

$x_{lookup}$  : Acceleration lookup factor. If the parameter is set to 0, the fixed acceleration lookup depth parameter is applied.

## 5.4 Output tab

The Output tab and its parameters are shown in Figure 5-3.

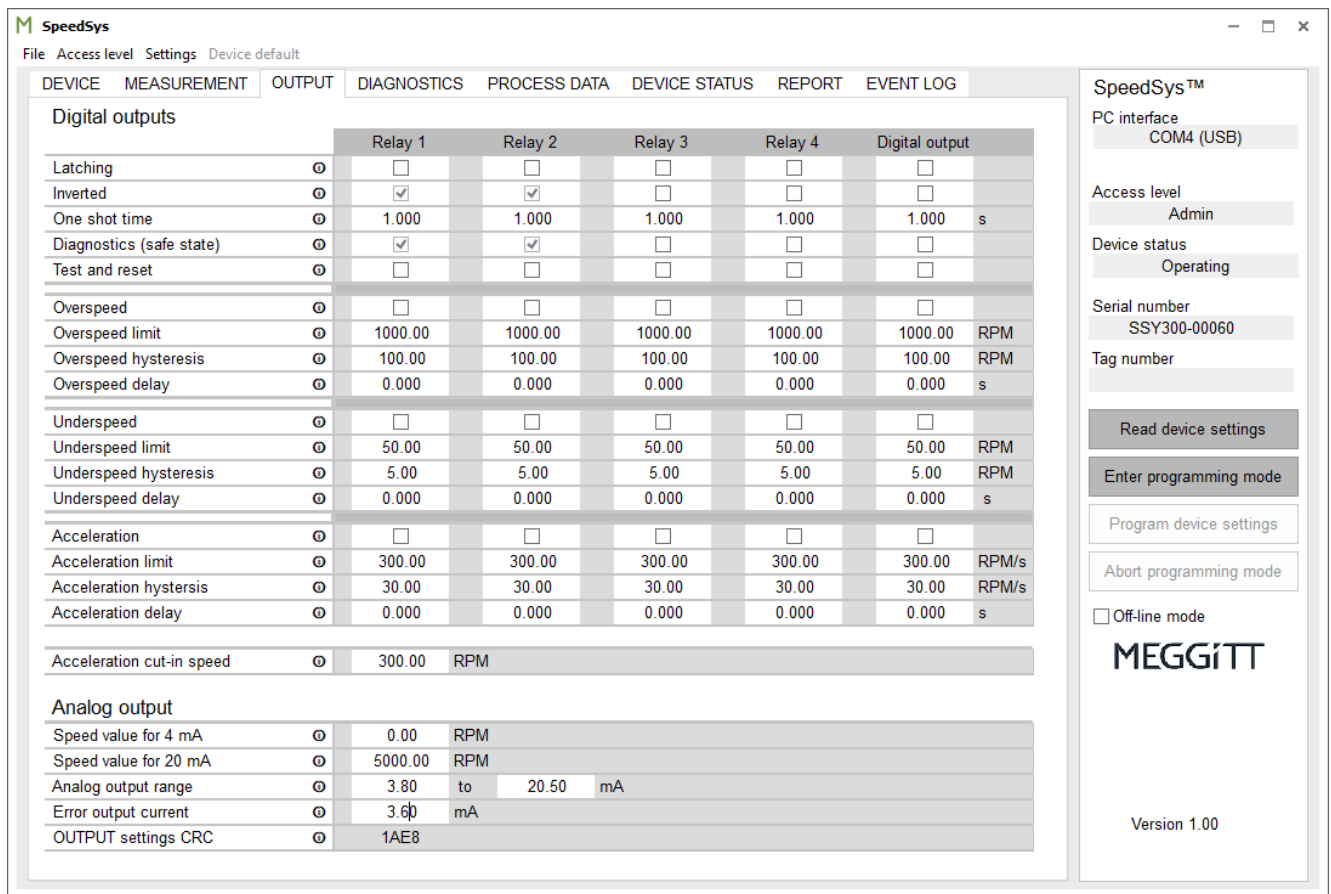

Figure 5-3: SpeedSys300 software – Output tab

The output configuration enables the user to define the behaviour of the digital outputs (relays and digital) as well as the analog output.

### 5.4.1 Output tab – Digital outputs

In general, each relay and the digital output can be configured individually. However, it is important to note that for the safety relays (Relay 1 and Relay 2), certain configuration parameters are restricted.

More specifically, for the safety relays, their configuration is fixed as normally energized / de-energize to trip (that is, Inverted is always selected). And their operation is also always connected to the module’s diagnostics so that a problem detected by the module will always drive the safety relays to the safe state (that is, Diagnostics (safe state) is always selected).

- Latching

The latching function is a set/reset of the relay. Once the alarm has been activated, the relay switches to the NOT OK state. This state is set and remembered, even when the alarm is removed.

The relays can be reset back to their normal states using the reset command. To reset the

relays, use one of the “Test and reset” buttons/commands on the Process data tab (see 5.6 Process data tab).

- Inverted

In case of activation, the relay switches to an open state instead of closing.

---

**NOTE:** For safety relay 1 and safety relay 2, Inverted is always selected.

---

- One shot time

Inoperable when Latching is activated. Defines the time delay for the relay to return to being operational after an initial trip signal

- Diagnostics (safe state)

Allows the system diagnostics to cause a trip signal. Trip events are listed on the Diagnostics tab.

---

**NOTE:** For safety relay 1 and safety relay 2, Diagnostics (safe state) is always selected.

---

- Test and reset

Allows the digital outputs (relays and digital) to respond to the “Test and Reset” commands in the Process data Tab.

- Overspeed ...

This category parametrizes the overspeed indication. Activate the checkbox to enable overspeed indication for the respective output. The upper limit value of the rotation frequency, as well as the hysteresis and delay can be individually configured.

- Underspeed ...

This category parametrizes the underspeed indication. Activate the checkbox to enable overspeed indication for the respective output. The lower limit value of the rotation frequency, as well as the hysteresis and delay can be individually configured.

- Acceleration ...

This category parametrizes the indication of acceleration violations. The upper limit for the acceleration can be configured, as well as the hysteresis and delay

- Overspeed / Underspeed / Acceleration hysteresis and delay

When the respective limit for overspeed or acceleration has been exceeded, the trip signal automatically latches until it falls below the limit minus the hysteresis. When an underspeed limit has been violated, the trip signal automatically latches until it rises above the limit plus the hysteresis. This is shown in the image below.

The delay adds to the total reaction time. A Trip is initiated if the duration of a trip event is at least as long as this time frame.



- Acceleration cut-in speed

Define this parameter to set the minimal speed for which acceleration alarms are indicated. Below this speed, no acceleration alarms are evaluated.

#### 5.4.2 Output tab – Analog output

- Speed value for 4 mA / 20 mA

Defines the speed corresponding to the analog current loop outputs of 4 mA and 20 mA, respectively. Effectively, these parameters define the desired measurement range.

- Error output current

Defines the current that the analog current loop will be driven to when a problem is detected by the module's diagnostics (that is, the safe state current value).

---

**NOTE:** For a SpeedSys300 ODS301 module, only Safety relay 1, Safety relay 2 and the Analog output are safety outputs and can be used to implement a safety function. All other outputs are non-safety outputs and must not be used to implement a safety function.

---

## 5.5 Diagnostics tab

The Diagnostics tab and its parameters are shown in Figure 5-4.

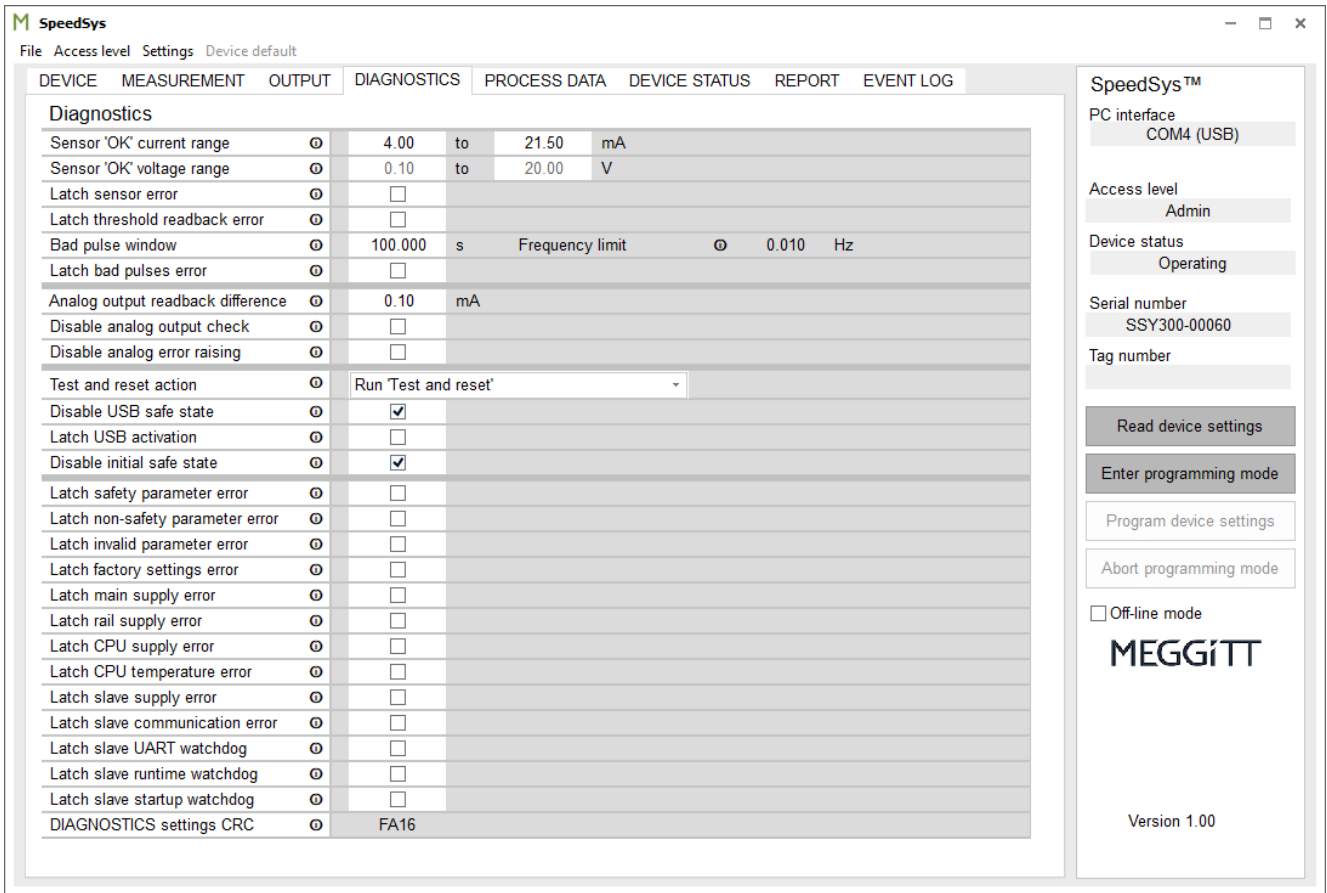

Figure 5-4: SpeedSys300 software – Diagnostics tab

### 5.5.1 Diagnostics tab – Diagnostics

The Sensor “OK” current / voltage range can be specified either as voltage or current range depending on the selected sensor type (see 5.3 Measurement tab). For example, for applications using a TQxxx/IQSxxx proximity measurement chain as the sensor input (Sensor type: 2-wire current), the recommended Sensor OK current range is 15.5 to 20.5 mA.

Internally, the SpeedSys300 ODS301 module implements redundant pulse detection circuitry, in order to allow self-diagnosis. If two or more differences between the two redundant channels are observed within the time frame of the 'Bad pulse window' parameter, a "bad pulse error" is raised for the duration of the Bad pulse window (see the image below).



The SpeedSys300 software enables the user to define which errors shall be latched for further diagnosis. In case an error for which latching has been activated, the error state will be stored until manual reset. During this time, the module remains in the safe state.

## 5.6 Process data tab

The Process data tab and its parameters are shown in Figure 5-5.

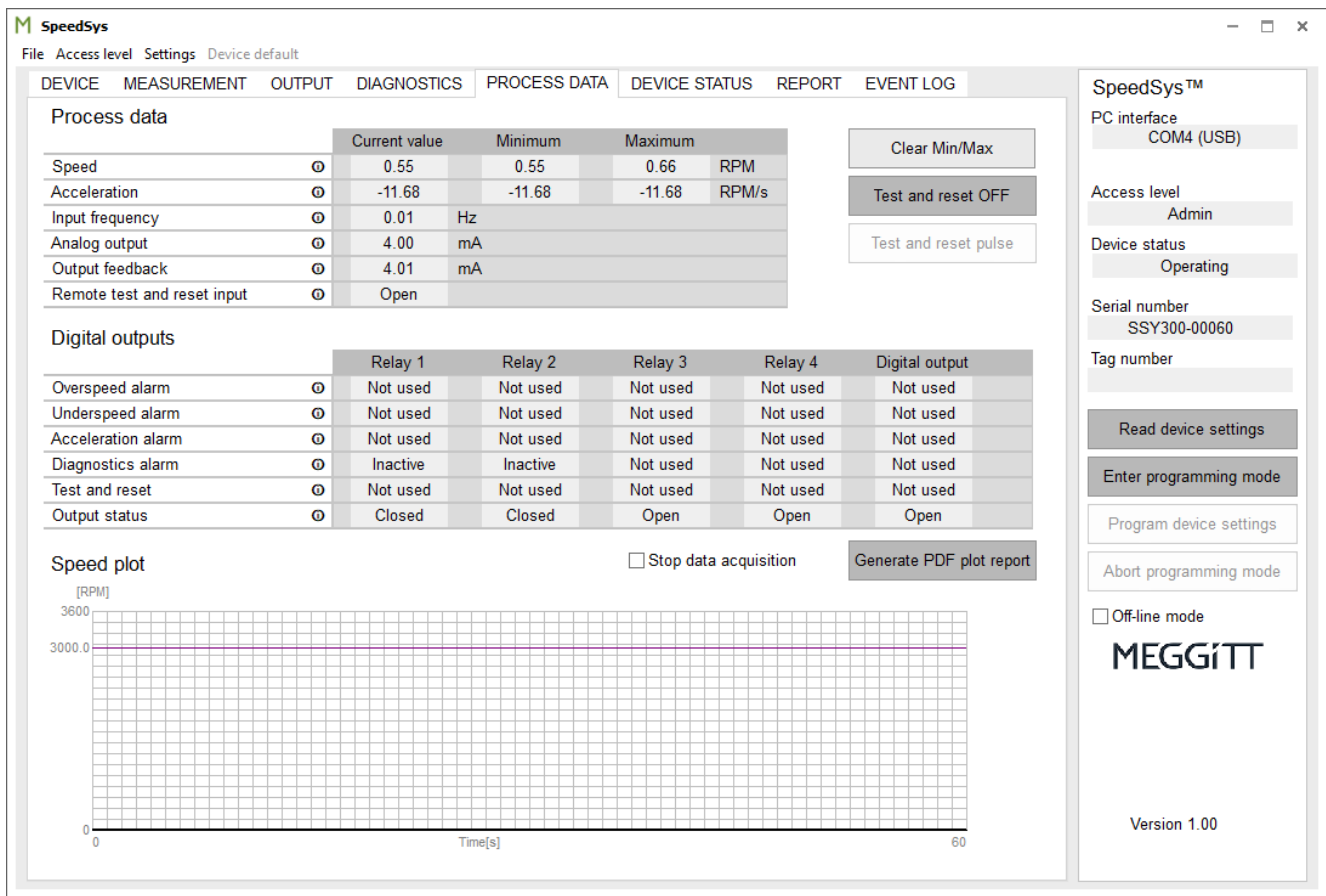

**Figure 5-5:** SpeedSys300 software – Process data tab

### 5.6.1 Process tab – Process data

Process data displays relevant information about the current state of the measured and calculated process parameters (sensor input and analog output), including the minimum and maximum values that are stored for speed and acceleration.

- Test and reset on

The Test and reset on (off) button/command is used to activate (deactivate) the “Test and reset” function, which will switch the relays based on the parameters/settings configured on the Output tab and the Diagnostics tab.

- Test and reset pulse

The Test and reset pulse button/command is used to activate the “Test and reset” function for 100 ms, which will temporarily switch the relays based on the parameters/settings configured on the Output tab and the Diagnostics tab.

### 5.6.2 Process tab – Digital outputs

Digital outputs displays relevant information about the current state/status of the digital outputs (relays and digital).

### 5.6.3 Process tab – Speed plot

The speed measurement history is shown in a Speed plot at the bottom of the window using an x-axis that is scaled to 60 s (fixed) and a y-axis that is scaled depending on the specified rated speed (user configurable; see 5.3 Measurement tab).

The Generate PDF plot report button/command is used to export a copy of the latest speed plot for the module to a PDF file.

## 5.7 Device status tab

The Device status tab and its parameters are shown in Figure 5-6.

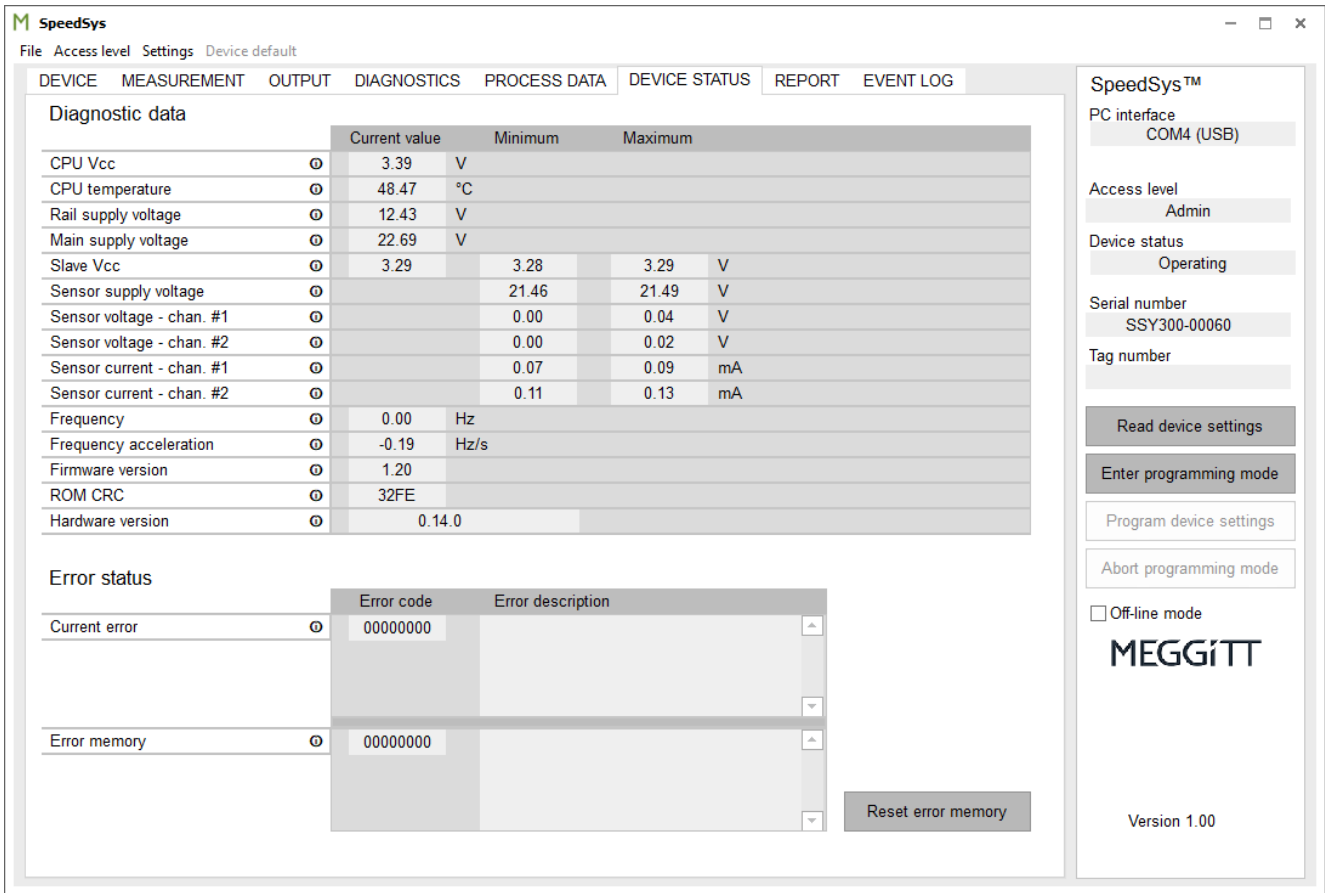

Figure 5-6: SpeedSys300 software – Device status tab

### 5.7.1 Device status tab – Diagnostic data

The Diagnostic data displayed includes real-time information on different internal parameters related to the SpeedSys300 ODS301 module’s hardware. For example, the user can observe the overall supply voltage and temperature (CPU) for the module as well as individual voltages and currents for the individual (redundant) sensor input channels.

The minimum and maximum values of the latest sampling period are stored, with these values being updated every sampling period.

The latest measurement values for frequency and acceleration are also displayed.

In addition, firmware version, memory cyclic redundancy check (CRC) and hardware version information for the module are listed.

### 5.7.2 Device status tab – Error status

On the bottom of the window, the error status is displayed. All current errors are displayed including the respective error code. Past errors are stored in the error memory to give the user the ability to identify potential problems/risks that are caused by short-term malfunctions or that remain undetected due to the short duration.

- Reset error memory

Use the Reset error memory button/command to clear the status errors stored by the module.

## 5.8 Report tab

The Report tab and its parameters are shown in Figure 5-7.

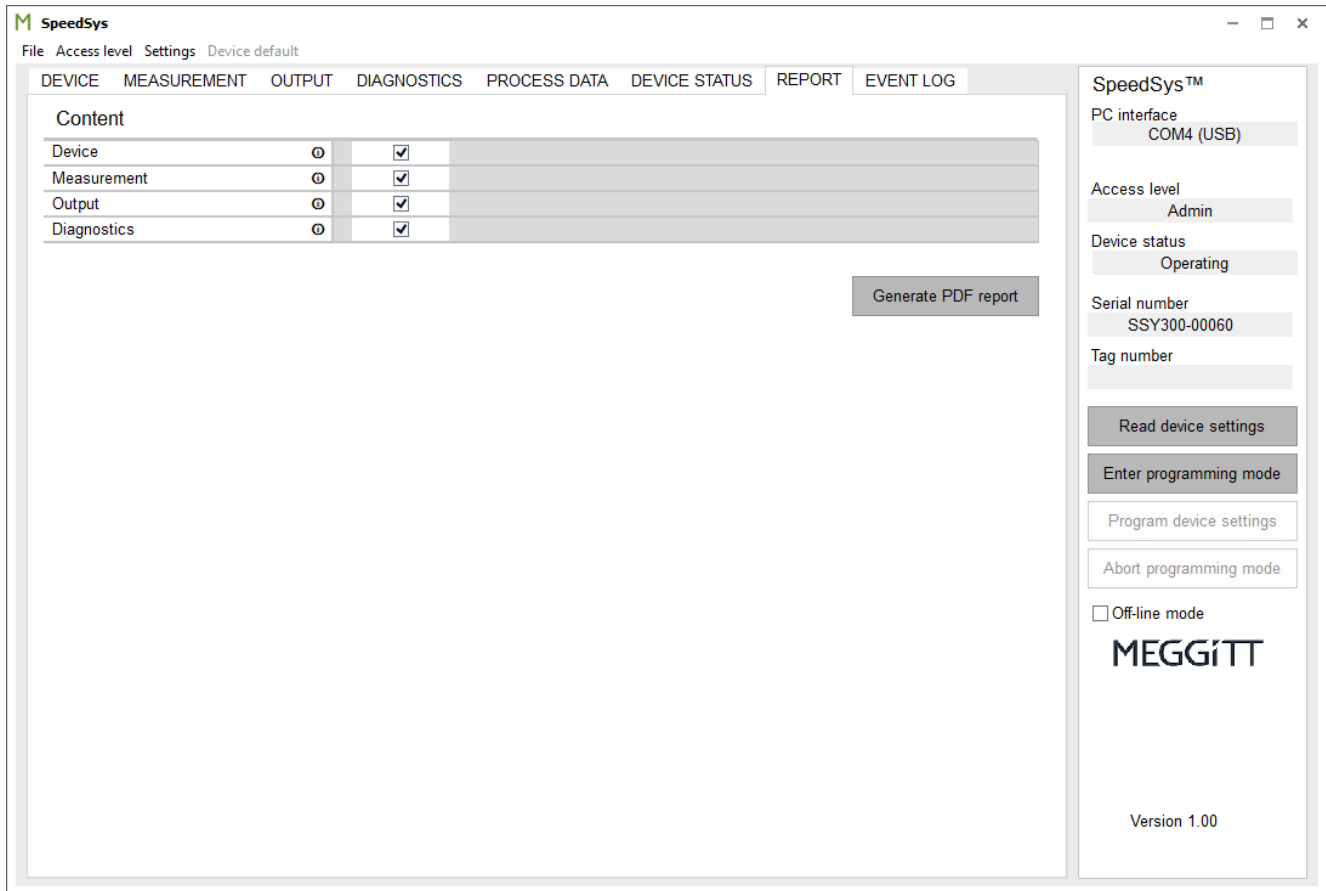

**Figure 5-7:** SpeedSys300 software – Report tab

### 5.8.1 Report tab – Content

The Content tab is used to generate a copy of the latest configuration information used and displayed by the SpeedSys300 software (SpeedSys300 ODS301) module as a PDF report file.

---

**NOTE:** PDF reports generated in this way contain human-readable configuration information (\*.pdf) that is equivalent to the computer-readable configuration information stored in a SpeedSys300 ODS301 system configuration file (\*.ssy), created using the **File > Save configuration** command.

---

The contents of the report can include Device, Measurement, Output and/or Diagnostics information (that is, the information configured using these respective tabs), by selecting the appropriate checkboxes.

- Generate PDF report

Use the Generate PDF report button/command to generate the report.



Each diagnostic error is identified by a unique hexadecimal error bit/code (Code (HEX)). If multiple errors occur at the same time, the codes are logically combined.

---

**NOTE:** Holding the mouse pointer mouse over an error in the Event log table (left) will highlight the associated errors in the Error codes summary (right).

---

For further information on each error code, see Appendix E: SpeedSys300 ODS301 diagnostic error codes.

- Load event log

Use the Load event log button/command to load the log of most recent events from the SpeedSys300 ODS301 module and display them in a table on the Event log tab (left).

- Export event log

Use the Export event log button/command to export the event log to a comma separated values file (\*.csv).

## 5.10 Programming parameters

After configuring the parameters in the SpeedSys300 software, the configuration has to be uploaded to the SpeedSys300 ODS301 module in order for the module to apply and run (activate) the updated configuration.

Activating a configuration on SpeedSys300 ODS301 module (that is, programming the module) is only possible when:

- The SpeedSys300 ODS301 module and SpeedSys300 software have been changed to the Admin access level.
- The SpeedSys300 ODS301 module (device) is set to its programming mode.

To upload (write) the configuration to the module:

- 1- The SpeedSys300 ODS301 module must be connected to a computer running the SpeedSys300 software and the module/software must be at the Admin access level (see 4.6 Access levels/permissions).
- 2- In the SpeedSys300 software, in the overall module information and controls window (right), click the **Enter programming mode** button.

When prompted to enter the programming mode, click **OK** to continue.



**ENTERING THE PROGRAMMING MODE WILL FORCE THE SPEEDSYS300 ODS301 MODULE AND ITS OUTPUTS INTO THEIR SAFE STATE. ACCORDINGLY, IT IS HIGHLY RECOMMENDED THAT MODULE PROGRAMMING IS ONLY PERFORMED IN ACCORDANCE WITH THE OPERATING PROCEDURES FOR THE MACHINERY BEING MONITORED AND THAT APPROPRIATE PRECAUTIONS ARE TAKEN AT THE CONTROL SYSTEM LEVEL (SUCH AS DCS OR PLC).**

Note that the overall module information and controls window (right) updates to display Device status: Programming – safe state.

- 3- In the overall module information and controls window (right), click the **Program device settings** button to program the module settings, that is, update the configuration.

When prompted to proceed and overwrite existing parameters, click **OK** to continue.

---

**NOTE:** Programming the module settings will overwrite all existing parameters on the SpeedSys300 ODS301 module.

More specifically, the module is completely reconfigured using all of the parameters configured/changed in the SpeedSys300 software.

---

When prompted to commit the changes, click **OK** to continue.

After the module has been updated:

- The SpeedSys300 ODS301 module will change from the Programming – safe state mode back to the Operating mode and run using the updated parameters.

At any stage, the programming of parameters can be cancelled by clicking the **Abort programming mode** button in the overall module information and controls window (right).

THIS PAGE INTENTIONALLY LEFT BLANK

## 6 MODBUS COMMUNICATIONS WITH A SPEEDSYS300 ODS301

This section provides an overview of the Modbus communications interface supported by the SpeedSys300 ODS301 module.

### 6.1 Introduction

The SpeedSys300 ODS301 module implements a Modbus server in order to allow the sharing of module information with external third-party systems, such as a DCS or PLC.

For communication with its Modbus server, the module provides a Modbus RTU serial (RS-485, half-duplex (2-wire)) interface, that is available on the MODBUS RS485 connector. See 2.2 SpeedSys300 ODS301 module connectors for further information on the MODBUS RS485 connector.

The default communication parameters for the SpeedSys300 ODS301 module's Modbus RTU interface are:

- Modbus address: 1 (slave).
- Modbus transmission speed: 19200 (baud rate).
- Number of data bits: 8.
- Number of stop bits: 1.
- Modbus parity check: None.
- Modbus line termination: Inactive.

All of these communication parameters, except for number of data and stop bits, can be changed if required using the SpeedSys300 software. See 5.2 Device tab and 5.2.1 Device tab – Configuration user for further information.

The data transmitted by the module consists of real-time measurement values (speed, acceleration, alarms and so on), status and/or configuration information. This data is typically used by external systems for the purposes of machinery monitoring. See 6.3 Modbus register definitions for detailed Modbus register definitions and mapping information.

It is important to note that SpeedSys300 ODS301 module's Modbus interface is read only and cannot be used to change the configuration or operation of the ODS301 module.

---

**NOTE:** The SpeedSys300 ODS301 module's Modbus interface is read only and the information to be shared is defined by the ODS301 module's configuration.

---

## 6.2 Modbus

Modbus started in the 1970s as a serial communications protocol published by Modicon for use with programmable logic controllers (PLCs). On a Modbus network, controllers communicate using a master-slave technique, in which only one device (the master) can initiate queries (transactions). The other devices on the network (the slaves) respond by supplying the requested data to the master, or by taking the action requested in the query.

Since then, Modbus has evolved into become one of the most widely used standards in industrial automation and control. It has become an application layer messaging protocol for client-server communication between devices connected on different types of buses or networks. However, it is still mainly used to exchange data in the field of automation.

Today, Modbus is a client-server protocol based on transactions (see Figure 6-1), which consist of:

- A request issued by the client
- A response issued by the server.

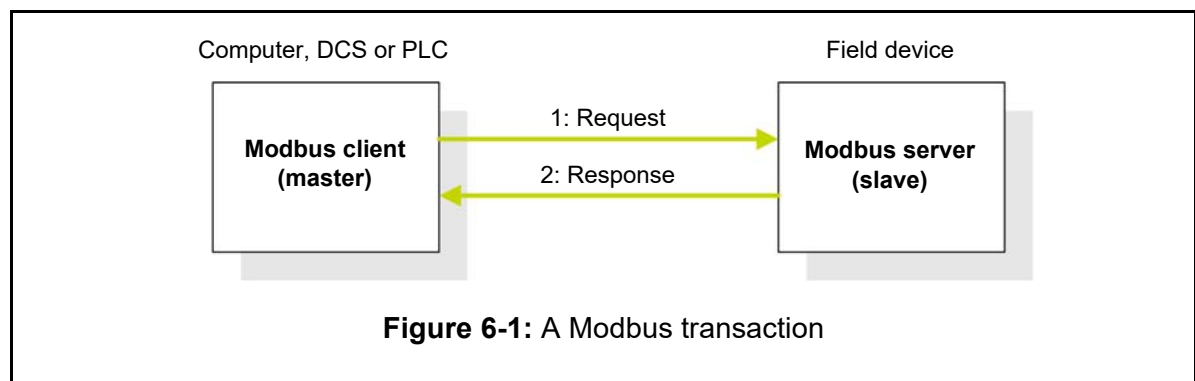

In this client-server model of Modbus communication, the SpeedSys300 ODS301 module is the Modbus server (slave) that responds to external transaction requests from client equipment, such as a computer or DCS.

Modbus is a request/response protocol and offers services specified by function codes.

Versions of the Modbus protocol exist for serial communication interfaces (the Modbus RTU protocol) and for Ethernet (the Modbus TCP protocol).

Visit the Modbus Organization website for the most up-to-date information:

<http://www.modbus.org/specs.php>

### 6.2.1 Modbus RTU

In general, the Modbus RTU protocol can be used with RS-232 and RS-485 serial interfaces, however, the SpeedSys300 ODS301 module's interface supports RS-485, half-duplex only. The address field of a Modbus RTU message frame contains eight bits so valid slave device addresses are in the range from 1 to 247 (decimal). (Address 00 is reserved for broadcast transactions to all server devices in a Modbus network.)

In practice, however, the maximum number of instruments or devices that can be addressed is limited by the RS-485 specification. This states that the bus can support up to 32 "unit loads", so the maximum number of devices that can be connected depends on how much each connected device loads the system down.

In general, the Modbus RTU protocol can be used with half-duplex or full-duplex serial interfaces, however, the SpeedSys300 ODS301 module's interface supports half-duplex (2-wire) only.

The default SpeedSys300 ODS301 module communication parameter settings are given in 6.1 Introduction.

### 6.3 Modbus register definitions

For detailed Modbus register definitions and mapping information, see Appendix F: SpeedSys300 ODS301 Modbus register definitions.

THIS PAGE INTENTIONALLY LEFT BLANK

## 7 MAINTENANCE

### 7.1 General

No specific maintenance is required for the SpeedSys300 ODS301 overspeed detection system (ODS) described in this manual, that is, for ODS301 modules.

---

**NOTE:** Any attempt by unauthorised personnel to modify or repair equipment still under guarantee will invalidate the warranty.

---

See 9.1 Contacting us for the contact details relevant to repairing defective hardware.

### 7.2 Requirements for equipment used in potentially explosive atmospheres



**WHERE MAINTENANCE IS REQUIRED, IT MUST BE PERFORMED ONLY BY EX QUALIFIED PERSONNEL WITH THE APPROPRIATE MATERIAL.**

**ANY MAINTENANCE WORK PERFORMED ON MEGGITT VIBRO-METER<sup>®</sup> EQUIPMENT THAT CAN BE USED IN POTENTIALLY EXPLOSIVE ATMOSPHERES (EX ZONES) MUST RESPECT THE CONDITIONS AND LIMITATIONS SPECIFIED IN THE EX CERTIFICATES FOR THE PRODUCT.**

**FOR FURTHER INFORMATION, SEE EQUIPMENT INSTALLED IN POTENTIALLY EXPLOSIVE ATMOSPHERES AND THE EX CERTIFICATES IN THE APPENDICES OF THIS MANUAL. (THE EX CERTIFICATES ARE ALSO AVAILABLE FROM OUR WEBSITE AT [WWW.MEGGITTSENSING.COM/ENERGY](http://WWW.MEGGITTSENSING.COM/ENERGY))**

**DO NOT ATTEMPT TO MODIFY OR REPAIR EQUIPMENT FROM MEGGITT'S VIBRO-METER<sup>®</sup> PRODUCT LINE THAT IS USED IN SUCH ENVIRONMENTS.**

### 7.3 Cleaning

It is not required to clean a SpeedSys300 ODS301 overspeed detection system (ODS).

However, if cleaning does become necessary:

- Clean with a dry cloth only.
- Keep away from live electrical parts.
- Do not use any solvents or cleaning agents. Never pour or spray any cleaner or liquid on the module.



**IF CLEANING BECOMES NECESSARY, USE A DRY CLOTH ONLY AND KEEP AWAY FROM POWERED ("LIVE") ELECTRICAL PARTS.**

**THIS PAGE INTENTIONALLY LEFT BLANK**

## 8 END-OF-LIFE PRODUCT DISPOSAL

A SpeedSys300 ODS301 overspeed detection system (ODS) is an electrical/electronic product, therefore, it must be disposed of in a acceptable manner at the end of its useful life. This is important in order to reduce pollution and improve resource efficiency.

---

**NOTE:** For environmental and economic reasons, end-of-life electrical and electronic equipment must be collected and treated separately from other waste: it must not go into landfill (or tip, dump, rubbish dump, garbage dump or dumping ground).

---

In Europe (the European Union), end-of-life electrical/electronic products are classed as waste electrical and electronic equipment (WEEE), and are subject to the requirements of the European Union (EU) directive 2012/19/EU on waste electrical and electronic equipment (commonly referred to as the WEEE directive).

According to the WEEE regulations, all waste electrical and electronic equipment should be collected separately and then treated and disposed of in accordance with the best available and environmentally friendly techniques. This is because electronic waste (or e-waste) may contain substances harmful to the environment and/or to human health. In addition, electronic waste is also a valuable source of raw materials that can contribute to a circular economy.

The WEEE symbol (a “crossed-out wheeled bin”) is used on product labelling to indicate equipment that must be properly treated and disposed of at the end of its life (see Figure 8-1).

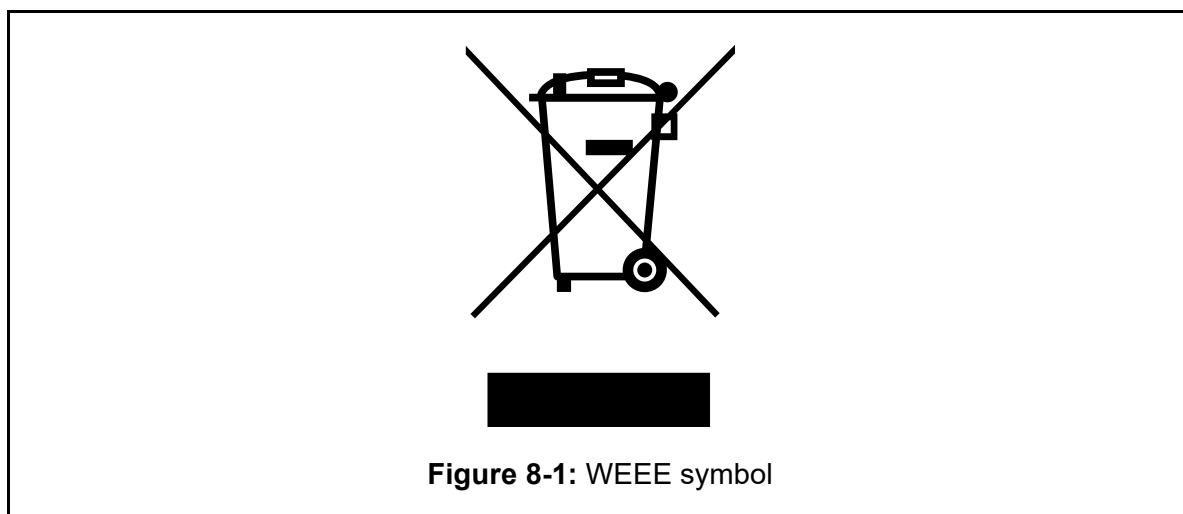

Although a number of non-EU countries have enacted WEEE regulations, different end-of-life product disposal laws and regulations apply in other countries and regions of the world. Accordingly, please consult your local authorities to obtain the information and guidance relevant to your country and region.

---

**NOTE:** At the end of their useful life, electrical/electronic products must be disposed of in an environmentally friendly manner.  
In European Union Member States, the WEEE directive is applicable.  
In other countries and regions of the world, different laws and regulations may be applicable, so please consult your local authorities.

---

For additional end-of-life product disposal information and guidance, contact your local Meggitt representative. Alternatively, contact our main office:

Environment, health and safety department

Meggitt SA

Route de Moncor 4

Case postale

1701 Fribourg

Switzerland

Telephone: +41 26 407 11 11

Email: [ehs@ch.meggitt.com](mailto:ehs@ch.meggitt.com)

Website: [www.meggittsensing.com/energy](http://www.meggittsensing.com/energy)

## 9 SERVICE AND SUPPORT

### 9.1 Contacting us

Meggitt's worldwide customer support network offers a range of support, including 9.2 Technical support and 9.3 Sales and repairs support. For customer support, contact your local Meggitt representative. Alternatively, contact our main office:

Customer support department

Meggitt SA

Route de Moncor 4

Case postale

1701 Fribourg

Switzerland

Telephone: +41 26 407 11 11

Email: [energysupport@ch.meggitt.com](mailto:energysupport@ch.meggitt.com)

Website: [www.meggittsensing.com/energy](http://www.meggittsensing.com/energy)

### 9.2 Technical support

Meggitt's technical support team provide both pre-sales and post-sales technical support, including:

- General advice
- Technical advice
- Troubleshooting
- Site visits.

---

**NOTE:** For further information, contact Meggitt (see 9.1 Contacting us).

---

### 9.3 Sales and repairs support

Meggitt's sales team provide both pre-sales and post-sales support, including advice on:

- New products
- Spare parts
- Repairs.

---

**NOTE:** If a product has to be returned for repairs, then it should be accompanied by a completed Energy product return form, included on page 9-4.

---

## 9.4 Customer feedback

As part of our continuing commitment to improving customer service, we warmly welcome your opinions. To provide feedback, complete the Energy customer feedback form on page 9-7 and return it to Meggitt SA's main office (see 9.1 Contacting us).

## REPAIRS AND RETURNS

### Energy product return procedure

If a Meggitt vibro-meter<sup>®</sup> Energy product needs to be returned to Meggitt Switzerland, please use the online product return procedure on the Meggitt vibro-meter<sup>®</sup> Energy website at [www.meggittsensing.com/energy/service-and-support/repair](http://www.meggittsensing.com/energy/service-and-support/repair)

As described on the website, the product return procedure is as follows:

- 1- Complete and submit online the **Energy product return form** that is available on the website (note: \* indicates a required field).

For each Energy product to be returned, a separate Energy product return form must be completed and submitted online. It is possible to return multiple items of the same product type with the same form (same part number (PNR), multiple serial numbers (SNRs) – separated with a coma “,”).

When an Energy product return form is submitted online, the website displays a message confirming that the form has been successfully sent.

- 2- When the Energy product return form has been processed by Meggitt Switzerland, a return merchandise authorisation (RMA) document with a unique RMA # reference number and containing a pre-filled end-user certificate (EUC) will be emailed by return. Received forms are typically processed and the RMA document sent within 2 working days.

---

**NOTE:** Please do not return any products to Meggitt Switzerland without a supporting return merchandise authorisation (RMA) document.  
Please use the RMA # reference number in all future communications regarding a product return.

---

- 3- Review, complete and sign the RMA document and also review, complete and sign the EUC that the RMA contains (separate signatures are required for each).

For each Energy product to be returned, an associated single-use end-user certificate (EUC) is required, unless your company has an annual end-user certificate (EUC) in place. Either end-user certificate can be used to cover multiple products.

Multiple items of the same product type (same part number (PNR), multiple serial numbers (SNRs)) are allowed for a single RMA and EUC.

- 4- Optionally, to support your internal processes, you may want to issue one purchase order (PO) per product (may include multiple items / serial numbers) and send it to Meggitt Switzerland.
- 5- Send the Energy product(s) together with printed and signed copies of the return merchandise authorisation (RMA) document (or documents) and the end-user certificate (or certificates) to Meggitt Switzerland at:

**Meggitt SA, Energy repairs department, Route de Moncor 4, Case postale, 1701 Fribourg, Switzerland.**

---

**NOTE:** The **Energy product return form** reproduced below is included to support the gathering of information required for completion and submission online.

---

## Energy product return form

### Contact information

First name:\*

Last name:\*

Job title:

Company:\*

Address:\*

Country:\*

Email:\*

Telephone:\*

Fax:

### Product information

Product type:\*

Part number (PNR):\*

Serial number (SER):

Note: Enter "Unknown" if the serial number (SER) is not known.

Ex product:

 Yes No

SIL product:\*

 Yes No

Meggitt SA purchase order number:

Date of purchase (dd.mm.yyyy):

Product under warranty:

 Yes No Don't know

Site where installed:

End user:

## Return information

Reason for return:\*

Repair

Calibration / recertification

Out-of-box problem

Return

If the reason for return is "Repair", please answer the following questions:\*

Type of problem:

How long was the operating time before failure?

Continuous

Intermittent

Temperature dependent

Description of failure:

Please provide a detailed description in order to help with problem diagnosis.

If the reason for return is "Out-of-box problem", please answer the following questions:\*

Type of out-of-box problem:

Product damaged

Incorrect product configuration

Incorrect product delivered

Problem with documentation / labelling

Product dead-on-arrival

Additional information:

Please provide as much information as possible in order to help with problem diagnosis.

**Ex product information – additional information required for Ex products only**

Is the product installed in a hazardous area (potentially explosive atmosphere)?:

Yes

No

If the product is installed in a hazardous area, please answer the following questions:

How long was the operating time before failure?:

Additional information:

**SIL product information – additional information required for SIL products only\***

Note: For SIL products used in functional safety contexts/systems, this **SIL product information** section must be completed.

Is the product installed in a safety-related system?:\*

Yes

No

If the product is installed in a safety-related system, please answer the following questions:\*

Did the system fail\*\* in a safe mode?:\* (That is, the safety relay operated but the trip was spurious.)

Yes

No

Not applicable

Did the system fail\*\* in a dangerous state?:\* (That is, the failure did not result in the safe state.)

Yes

No

Not applicable

How long was the operating time before failure (in hours)?:\*

Additional information:

\*\* A faulty indicator LED is considered as a cosmetic failure.

## FEEDBACK

### Energy customer feedback form

#### Manual information

Title of manual:

*SpeedSys300 ODS301 overspeed detection system (ODS)  
user manual*

Reference: MAODS301/E

Version: Edition 2

Date of issue: June 2021

#### Customer contact information

First name:\*

Last name:\*

Job title:

Company:\*

Address:\*

Country:\*

Email:\*

Telephone:\*

Fax:

**Feedback – general**

Please answer the following questions:

- |  |                              |                             |
|--|------------------------------|-----------------------------|
| Is the document well organised?                | <input type="checkbox"/> Yes | <input type="checkbox"/> No |
| Is the information technically accurate?       | <input type="checkbox"/> Yes | <input type="checkbox"/> No |
| Is more technical detail required?             | <input type="checkbox"/> Yes | <input type="checkbox"/> No |
| Are the instructions clear and complete?       | <input type="checkbox"/> Yes | <input type="checkbox"/> No |
| Are the descriptions easy to understand?       | <input type="checkbox"/> Yes | <input type="checkbox"/> No |
| Are the examples and diagrams/photos helpful?  | <input type="checkbox"/> Yes | <input type="checkbox"/> No |
| Are there enough examples and diagrams/photos? | <input type="checkbox"/> Yes | <input type="checkbox"/> No |
| Is the style/wording easy to read?             | <input type="checkbox"/> Yes | <input type="checkbox"/> No |
| Is any information not included?               | <input type="checkbox"/> Yes | <input type="checkbox"/> No |

Please include any additional information in the “Feedback – additional” section below.

**Feedback – additional**

Additional information:

Please provide as much feedback as possible in order to help us improve our product documentation.  
Continue on a separate sheet if necessary ...

## APPENDIX A: ENVIRONMENTAL SPECIFICATIONS

Table A-1 summarises the environmental conditions/specifications for the SpeedSys300 ODS301 module (SpeedSys300 ODS301 overspeed detection systems).

**NOTE:** Refer to the *SpeedSys300 ODS301 overspeed detection system data sheet* for further information on environmental conditions/specifications.

**Table A-1:** Environmental specifications summary

<b>Power supply (to ODS301)</b>	
Input voltage range	24 V <sub>DC</sub> nominal (18 to 36 V <sub>DC</sub> )
Current consumption	220 mA (with 24 V <sub>DC</sub> nominal supply). <315 mA max.
<b>Temperature</b>	
Operating	-20 to 60°C (-4 to 140°F)
Storage	-40 to 85°C (-40 to 185°F)
<b>Humidity</b>	
Operating	5 to 80% non-condensing
Storage	5 to 85% non-condensing
<b>Safety</b>	
Electrical safety	Conforms to IEC/EN 61010-1: Safety requirements for electrical equipment for measurement, control and laboratory use
<b>Other</b>	
Protection rating (according to IEC 60529)	IP20. Note: The SpeedSys300 ODS301 module is suitable for indoor use only unless it is installed in an industrial housing or enclosure that ensures a higher level of environmental protection.
Indoor use	Limited to indoor use only
Power supply overvoltage category	OVC I
Pollution degree	2. Note: For use in environments where, normally, only non-conductive pollution occurs. Occasionally, however, a temporary conductivity caused by condensation may be expected.
Altitude	Max. 2000 m (6550 ft). Note: Reduced air density affects cooling ability.

**THIS PAGE INTENTIONALLY LEFT BLANK**

## APPENDIX B: ATEX CERTIFICATIONS

**Table B-1:** Related ATEX certificates

<b>Product(s) covered</b>	<b>Certificate number</b>
SpeedSys300 ODS301	IBExU 20 ATEX 1157

**THIS PAGE INTENTIONALLY LEFT BLANK**

EX CERTIFICATE – ATEX

---

vibro-meter®

---

IBExU 20 ATEX 1157  
for  
SpeedSys300 ODS301  
overspeed detection system

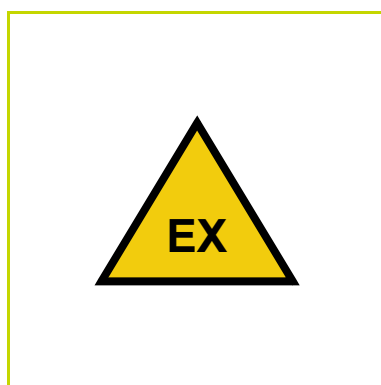

Note: Although the Ex certificate may be included in more than one language, the liability of the notified body applies only on the text of the original copy of the certificate that it published.

Document reference IBExU 20 ATEX 1157  
Edition 2 – June 2021

THIS PAGE INTENTIONALLY LEFT BLANK

**IBEXU Institut für Sicherheitstechnik GmbH**  
An-Institut der TU Bergakademie Freiberg

**EU-TYPE EXAMINATION CERTIFICATE - Translation**



- [1] Equipment or protective systems intended for use in potentially explosive atmospheres, Directive 2014/34/EU
- [2] EU-type examination certificate number **IBEXU20ATEX1157** | Issue 0
- [3] Product: **Overspeed Protection System**  
Type: SpeedSys 200 and SpeedSys300
- [4] Manufacturer: Istec International BV
- [5] Address: Meer en Duin 8  
2163 HA Lisse  
NETHERLANDS

[7] This product and any acceptable variation thereto is specified in the schedule to this certificate and the documents therein referred to.

[8] IBEXU Institut für Sicherheitstechnik GmbH, Notified Body number 0637 in accordance with Article 17 of Directive 2014/34/EU of the European Parliament and of the Council, dated 26 February 2014, certifies that this product has been found to comply with the essential health and safety requirements relating to the design and construction of products intended for use in potentially explosive atmospheres given in Annex II to the Directive.

The examination and test results are recorded in the confidential test report IB-20-3-0191.

[9] Compliance with the essential health and safety requirements has been assured by compliance with: EN IEC 60079-0:2018 and EN 60079-11:2012

Except in respect of those requirements listed at item [18] of the schedule.

If the sign "X" is placed after the certificate number, it indicates that the product is subject to the specific conditions of use specified in the schedule to this certificate.

[11] This EU-type examination certificate relates only to the design and construction of the specified product. Further requirements of the Directive apply to the manufacturing process and supply of this product. These are not covered by this certificate.

[12] The marking of the product shall include the following:

Ex II (1)G [Ex ia Ga] IIC  
Ex II (1)D [Ex ia Da] IIIC

Tel: + 49 (0) 37 31 / 38 05 0  
Fax: + 49 (0) 37 31 / 38 05 10

Certificates without signature and seal are not valid. Certificates may only be duplicated completely and unchanged. In case of dispute, the German text shall prevail.



IBEXU Institut für Sicherheitstechnik GmbH  
Fuchsmühlenweg 7  
09599 Freiberg, GERMANY

By order

Dipl.-Ing. Willamowski

Freiberg, 2021-02-23

**IBEXU Institut für Sicherheitstechnik GmbH**  
An-Institut der TU Bergakademie Freiberg

**Schedule**

[13]

Certificate number **IBEXU20ATEX1157** | Issue 0

**Description of product**

The Overspeed Protection System type SpeedSys 200 and SpeedSys300 serves as associated equipment for the galvanically isolated supply of a speed sensor and for recording its pulses. The device also offers a large number of digital and analogue inputs and outputs for connection to other devices. With regard to the intrinsically safe circuit section, both types are of identical design. The interface unit is installed in the safe area.

**Technical data**

Ambient temperature range: -20 °C to +60 °C

**Electrical data**

**Supply input (A17-A18, A21-A22)**

U <sub>N</sub>	18...38 V DC
U <sub>m</sub>	250 V
I <sub>N</sub>	<315 mA

**Current-loop output (A13-A14)**

U <sub>N</sub>	20 V DC
U <sub>m</sub>	125 V
I <sub>N</sub>	<63 mA

**Relay output (B13-B14, B15-B16, B17-B18, B19-B20, B21-B22, B23-B24)**

U <sub>N</sub>	30 V DV
I <sub>N</sub>	2 A
P	60 W
U <sub>m</sub>	220 V

**USB + RS485 interface (USB, C17-C18-C19)**

U <sub>N</sub>	5 V or 6 V DC
U <sub>m</sub>	125 V
I <sub>N</sub>	<63 mA

**Digital input or output (A15-A16, C13-C14, C15-C16)**

U <sub>N</sub>	24 V DC
U <sub>m</sub>	125 V
I <sub>N</sub>	<100 mA

**Output circuits (only one used):**

**2-wire voltage Sensorstromkreis (B01-B02)**

U <sub>0</sub>	in type of protection Intrinsic Safety Ex ia IIC
I <sub>0</sub>	22.69 V
P <sub>0</sub>	0.7 mA
L <sub>0</sub>	3 mW
C <sub>0</sub>	100 mH
	110 nF

**3-wire voltage Sensorstromkreis (B05-B06-B07)**

U <sub>0</sub>	in type of protection Intrinsic Safety Ex ia IIC
I <sub>0</sub>	22.69 V
P <sub>0</sub>	66 mA
L <sub>0</sub>	374 mW
C <sub>0</sub>	0.5 mH
	110 nF

**IBExU Institut für Sicherheitstechnik GmbH**

An-Institut der TU Bergakademie Freiberg

**Current-loop Sensorstromkreis (B09-B10)** in type of protection Intrinsic Safety Ex ia IIC

U <sub>0</sub>	22.69 V
I <sub>0</sub>	57.9 mA
P <sub>0</sub>	689 mW
L <sub>0</sub>	0.23 mH
C <sub>0</sub>	47 nF
R <sub>i</sub>	832 Ω

Characteristic trapezoidal

**[16] Test report**

The test results are recorded in the confidential test report IB-20-3-0191 of 2021-02-23. The test documents are part of the test report and they are listed there.

*Summary of the test results*

The Overspeed Protection System type SpeedSys 200 and SpeedSys300 fulfills the requirements of type of protection intrinsic safety 'ia' to associated apparatus of equipment group II, category 1G and 1D, explosion group IIC and IIIC.

**[17] Specific conditions of use**

none

**[18] Essential health and safety requirements**

In addition to the essential health and safety requirements (EHSRs) covered by the standards listed at item [9], the following are considered relevant to this product, and conformity is demonstrated in the test report:

none

**[19] Drawings and Documents**

The documents are listed in the test report.

IBExU Institut für Sicherheitstechnik GmbH  
Fuchsmühlenweg 7  
09599 Freiberg, GERMANY

By order



Dipl.-Ing. Willamowski

Freiberg, 2021-02-23

**IBEXU Institut für Sicherheitstechnik GmbH**  
An-Institut der TU Bergakademie Freiberg

- [13] **Anlage**
- [14] **Bescheinigung Nummer IBEXU20ATEX1157** | Ausgabe 0
- [15] **Beschreibung des Produkts**  
Das Overspeed Protection System Typ SpeedSys 200 und SpeedSys300 dient als zugehöriges Betriebsmittel der galvanisch getrennten Versorgung eines Drehzahlsensors und zur Erfassung seiner Impulse. Das Gerät bietet außerdem eine Vielzahl von digitalen und analogen Ein- und Ausgängen zum Anschluss an weitere Geräte. Hinsichtlich des eigensicheren Schaltungssteils sind beide Typen identisch aufgebaut. Die Installation der Interface-Einheit erfolgt im sicheren Bereich.

**Technische Daten**  
Umgebungstemperaturbereich: von -20 °C bis +60 °C

**Elektrische Daten**

**Stromversorgung (A17-A18, A21-A22)**  
Nennspannung  $U_N$  18...36 V DC  
max. Spannung  $U_m$  250 V  
Nennstrom  $I$  <315 mA

**Signalausgang (A13-A14)**  
Nennspannung  $U_N$  20 V DC  
max. Spannung  $U_m$  125 V  
Nennstrom  $I$  <63 mA

**Relay Ausgänge (B13-B14, B15-B16, B17-B18, B19-B20, B21-B22, B23-B24)**  
Schaltspannung  $U_N$  30 V DV  
 $I$  2 A  
Schaltleistung  $P$  60 W  
max. Spannung  $U_m$  220 V

**USB + RS485 interface (USB, C17-C18-C19)**  
Nennspannung  $U_N$  5 V oder 6 V DC  
max. Spannung  $U_m$  125 V  
Nennstrom  $I$  <63 mA

**Digitale Ein oder Ausgänge (A15-A16, C13-C14, C15-C16)**  
Nennspannung  $U_N$  24 V DC  
max. Spannung  $U_m$  125 V  
Nennstrom  $I$  <100 mA

Ausgangsstromkreise (nur einer verwendet):

**2-wire voltage Sensorstromkreis (B01-B02)**

in Zündschutzart Eigensicherheit Ex ia IIC  
 $U_o$  22,69 V  
 $I_o$  0,7 mA  
 $P_o$  3 mW  
 $L_o$  100 mH  
 $C_o$  110 nF

**3-wire voltage Sensorstromkreis (B05-B06-B07)**

in Zündschutzart Eigensicherheit Ex ia IIC  
 $U_o$  22,69 V  
 $I_o$  66 mA  
 $P_o$  374 mW  
 $L_o$  0,5 mH  
 $C_o$  110 nF

**IBEXU Institut für Sicherheitstechnik GmbH**  
An-Institut der TU Bergakademie Freiberg

- [1] **EU-BAUMUSTERPRÜFBESCHEINIGUNG**
- [2] Geräte und Schutzsysteme zur bestimmungsgemäßen Verwendung in explosionsgefährdeten Bereichen, Richtlinie 2014/34/EU
- [3] EU-Baumusterprüfbescheinigung Nummer **IBEXU20ATEX1157** | Ausgabe 0

[4] **Produkt:** Overspeed Protection System  
Typ: SpeedSys 200 und SpeedSys300

[5] **Hersteller:** Istec International BV

[6] **Anschrift:** Meer en duin 8  
2163 HA Lisse  
NETHERLANDS

[7] Dieses Produkt sowie die verschiedenen zulässigen Ausführungen sind in der Anlage zu dieser Bescheinigung sowie den darin aufgeführten Unterlagen festgelegt.

[8] IBEXU Institut für Sicherheitstechnik GmbH, notifizierte Stelle mit der Nummer 0637 in Übereinstimmung mit Artikel 17 der Richtlinie 2014/34/EU des Europäischen Parlaments und des Rates vom 26. Februar 2014, bestätigt, dass dieses Produkt die wesentlichen Sicherheits- und Gesundheitsanforderungen für die Konzeption und den Bau von Produkten zur bestimmungsgemäßen Verwendung in explosionsgefährdeten Bereichen aus Anhang II der Richtlinie erfüllt.

[9] Die Untersuchungs- und Prüfergebnisse werden in dem vertraulichen Prüfbericht IB-20-3-0191 festgehalten.

[10] Die Beachtung der wesentlichen Sicherheits- und Gesundheitsanforderungen wurde in Übereinstimmung mit folgenden Normen gewährleistet:  
EN IEC 60079-0:2018 und EN 60079-11:2012

[11] Hiervon ausgenommen sind jene Anforderungen, die unter Punkt [18] der Anlage aufgelistet werden.  
Ein „X“ hinter der Bescheinigungsnummer weist darauf hin, dass das Produkt den besonderen Bedingungen für die Verwendung unterliegt, die in der Anlage zu dieser Bescheinigung festgehalten sind.

[12] Diese EU-Baumusterprüfbescheinigung bezieht sich ausschließlich auf die Konzeption und den Bau des angegebenen Produkts. Für den Fertigungsprozess und die Bereitstellung dieses Produkts gelten weitere Anforderungen der Richtlinie. Diese fallen jedoch nicht in den Anwendungsbereich dieser Bescheinigung.

[13] Die Kennzeichnung des Produkts muss eines der folgenden in Abhängigkeit der verwendeten Komponenten beinhalten:

Ex II (1)G [Ex ia Ga] IIC  
Ex II (1)D [Ex ia Da] IIIC

IBEXU Institut für Sicherheitstechnik GmbH  
Fuchsmühlenweg 7  
09599 Freiberg, GERMANY

Teil: + 49 (0) 37 31 / 38 05 0  
Fax: + 49 (0) 37 31 / 38 05 10

Bescheinigungen ohne Siegel und Unterschrift haben keine Gültigkeit. Bescheinigungen dürfen nur vollständig und unverändert vervielfältigt werden.

Im Auftrag  
  
Dipl.-Ing. Williamowski



Freiberg, 23.02.2021

**IBEXU Institut für Sicherheitstechnik GmbH**  
An-Institut der TU Bergakademie Freiberg

**Current-loop Sensorstromkreis (B09-B10)** in type of protection Intrinsic Safety Ex ia IIC  
 $U_o$  22.69 V  
 $I_b$  57.9 mA  
 $P_o$  689 mW  
 $L_o$  0.23 mH  
 $C_o$  47 nF  
 $R_i$  832  $\Omega$

Characteristic trapezoidal

**[16] Test report**

The test results are recorded in the confidential test report IB-20-3-0191 of 2021-02-23. The test documents are part of the test report and they are listed there.

*Summary of the test results*

The Overspeed Protection System type SpeedSys 200 and SpeedSys300 fulfills the requirements of type of protection intrinsic safety 'ia' to associated apparatus of equipment group II, category 1G and 1D, explosion group IIC and IIIC.

**[17] Specific conditions of use**

none

**[18] Essential health and safety requirements**

In addition to the essential health and safety requirements (EHSRs) covered by the standards listed at item [9], the following are considered relevant to this product, and conformity is demonstrated in the test report:

none

**[19] Drawings and Documents**

The documents are listed in the test report.

IBEXU Institut für Sicherheitstechnik GmbH  
Fuchsmühlenweg 7  
09599 Freiberg, GERMANY

By order



Dipl.-Ing. Willamowski

Freiberg, 2021-02-23

## APPENDIX C: IECEX CERTIFICATIONS

Table C-1: Related IECEX certificates

Product(s) covered	Certificate number
SpeedSys300 ODS301	IECEX IBE 20.0045

**THIS PAGE INTENTIONALLY LEFT BLANK**

EX CERTIFICATE – IECEx

---

vibro-meter®

---

IECEx IBE 20.0045  
for  
SpeedSys300 ODS301  
overspeed detection system

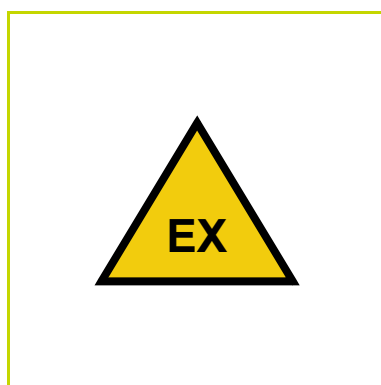

Note: Although the Ex certificate may be included in more than one language, the liability of the notified body applies only on the text of the original copy of the certificate that it published.

Document reference IECEx IBE 20.0045  
Edition 1 – April 2021

THIS PAGE INTENTIONALLY LEFT BLANK



## IECEX Certificate of Conformity

**INTERNATIONAL ELECTROTECHNICAL COMMISSION**  
**IEC Certification System for Explosive Atmospheres**  
for rules and details of the IECEx Scheme visit [www.iecex.com](http://www.iecex.com)

Page 1 of 3  
Issue No: 0  
Certificate history: [Certificate history](#)

---

Certificate No.:	IECEX IBE 20.0045		
Status:	Current		
Date of Issue:	2021-02-23		
Applicant:	Istec International B.V. Meer en Duin 8 2163 HA Lisse Netherlands		
Equipment:	Overspeed Protection System SpeedSys 200 and SpeedSys300		
Optional accessory:			
Type of Protection:	Intrinsic safety		
Marking:	[Ex ia Ga] IIC [Ex ia Da] IIC		

Approved for issue on behalf of the IECEx Certification Body:

Position: Kai Wiliamowski  
Head of department Certification Body



Signature:   
(or printed version)

Date: 23.01.2021



1. This certificate and schedule may only be reproduced in full.  
 2. This certificate is not transferable and remains the property of the issuing body.  
 3. The Status and authenticity of this certificate may be verified by visiting [www.iecex.com](http://www.iecex.com) or use of this QR Code.

Certificate issued by:  
**IBEXU**  
 Institut für Sicherheitstechnik GmbH  
 Fuchsmühlweg 7  
 09599 Freiberg  
 Germany

## IECEX Certificate of Conformity

Page 2 of 3  
Issue No: 0

---

Certificate No.:	IECEX IBE 20.0045		
Date of Issue:	2021-02-23		
Manufacturer:	Istec International B.V. Meer en Duin 8 2163 HA Lisse Netherlands		
Additional manufacturing locations:			

This certificate is issued as verification that a sample(s), representative of production, was assessed and tested and found to comply with the IEC Standard list below and that the manufacturer's quality system, relating to the Ex products covered by this certificate, was assessed and found to comply with the IECEx quality system requirements. This certificate is granted subject to the conditions as set out in IECEx Scheme Rules, IECEx 02 and Operational Documents as amended

**STANDARDS :**  
 The equipment and any acceptable variations to it specified in the schedule of this certificate and the identified documents, was found to comply with the following standards

IEC 60079-0:2017	Explosive atmospheres - Part 0: Equipment - General requirements		
IEC 60079-11:2011	Explosive atmospheres - Part 11: Equipment protection by intrinsic safety "I"		

This Certificate **does not** indicate compliance with safety and performance requirements other than those expressly included in the Standards listed above.

**TEST & ASSESSMENT REPORTS:**  
 A sample(s) of the equipment listed has successfully met the examination and test requirements as recorded in:

Test Report:	DE/IBEXE/TR20.0050/00		
Quality Assessment Report:	NL/KIWA/QAR20.0002/00		

## IECEX Certificate of Conformity

Certificate No.: **IECEX IBE 20.0045** Issue No: 0

Date of issue: **2021-02-23** Page 3 of 3

**EQUIPMENT:**  
 Equipment and systems covered by this Certificate are as follows:  
 The Overspeed Protection System type SpeedSys 200 and SpeedSys300 serves as associated equipment for the galvanically isolated supply of a speed sensor and for recording its pulses. The device also features a variety of digital and analog in- and outputs, to connect to further equipment. With regard to the intrinsically safe circuit section, both types are of identical design. The interface unit is installed in the safe area. Electrical data see Annex

**SPECIFIC CONDITIONS OF USE: NO**

**Annex:**  
 Ex:TR20.0050-AnnexCoC-IB2030191\_ah.pdf

## IECEX Certificate of Conformity - Annex

Certificate No.: **IECEX IBE 20.0045** Issue No: 0

Date of issue: **2021-02-23** Page 1 of 1

**Power supply circuit 1 and 2 (terminals A17-A18, A21-A22)**

Rated voltage	$U_N$	18...36 V DC
Current consumption	$I_N$	<315 mA
Max. voltage	$U_m$	250 V

**Non-intrinsically safe current output circuit (terminals A13-A14)**

Rated voltage	$U_N$	20 V DC
Rated current	$I_N$	<63 mA
Max. voltage	$U_m$	125 V

**Non-intrinsically safe relay circuits (terminals B13-B14, B15-B16, B17-B18, B19-B20, B21-B22, B23-B24)**

Switching voltage	$U_N$	30 V DC
Switching current	$I_N$	2 A
Switching power	P	60 W
Max. voltage	$U_m$	220 V

**Non-intrinsically safe USB circuit**

Rated voltage	$U_N$	5 V DC
Rated current	$I_N$	<63 mA
Max. voltage	$U_m$	125 V

**Non-intrinsically safe RS.485 circuit (terminals C17-C18-C19)**

Rated voltage	$U_N$	6 V DC
Rated current	$I_N$	<63 mA
Max. voltage	$U_m$	125 V

**Non-intrinsically safe digital outputs (terminals A15-A16, C13-C14, C15-C16)**

Rated voltage	$U_N$	24 V DC
Rated current	$I_N$	<100 mA
Max. voltage	$U_m$	125 V

**2-wire voltage sensor circuit (terminals B01-B02)**

Rated voltage	$U_o$	22.69 V	in ignition protection type intrinsic safety Ex ia IIC
Rated current	$I_o$	0.7 mA	
Max. voltage	$P_o$	3 mW	
	$L_o$	100 mH	
	$C_o$	110 nF	

**3-wire voltage sensor circuit (terminals B05-B06-B07)**

Rated voltage	$U_o$	22.69 V	in ignition protection type intrinsic safety Ex ia IIC
Rated current	$I_o$	69.5 mA	
Max. voltage	$P_o$	394 mW	
	$L_o$	0.5 mH	
	$C_o$	110 nF	

**Current-loop sensor circuit (terminals B09-B10)**

Rated voltage	$U_o$	22.69 V	in ignition protection type intrinsic safety Ex ia IIC
Rated current	$I_o$	57.9 mA	
Max. voltage	$P_o$	689 mW	
	$L_o$	0.23 mH	
	$C_o$	47 nF	
Characteristic	$R_o$	832 $\Omega$	

F8107009\_1\_170526 | Voltage: 00V0002170\_170117 | offentich

## APPENDIX D: FREQUENTLY ASKED QUESTIONS (FAQ)

### D.1 The SpeedSys300 software cannot communicate with my SpeedSys300 ODS301 module. What do I need to check?

When getting started and using the SpeedSys300 software on a computer for the first time, problems with drivers can result in the SpeedSys300 software not communicating with the SpeedSys300 ODS301 module, typically characterised by the SpeedSys300 software's Device status displaying "Not connected!" all of the time (even when everything is connected and powered correctly).

Basically, SpeedSys300 software to SpeedSys300 ODS301 module communication uses a FT230X Basic UART in the background, so the appropriate driver for this UART must be available on the computer running the SpeedSys300 software.

If the FT230X Basic UART is not available on the computer, Windows typically reports this as a message when the USB cable to a powered SpeedSys300 ODS301 is plugged/unplugged. Also, Windows Device Manger will typically display the SpeedSys300 ODS301 module as a unknown device, for example:



If the appropriate driver for the UART is not already installed on the computer running the SpeedSys300 software, it is available from the FTDI website, here:  
<https://ftdichip.com/drivers>

Specifically, this link:

Windows Driver Installer (VCP & D2XX), please click here.

(This links to [https://ftdichip.com/wp-content/uploads/2021/02/CDM21228\\_Setup.zip](https://ftdichip.com/wp-content/uploads/2021/02/CDM21228_Setup.zip) and downloads the Windows Driver Installer as a zip file.)

Downloading, unzipping and running this driver installer will install the appropriate driver for the UART. After which, Windows should automatically and correctly detect the SpeedSys300 ODS301 module. With the correct driver installed, Windows Device Manger will typically display a USB Serial Port (COMx) that should be used for communication with the SpeedSys300 ODS301 module, for example:



---

It is the USB Serial Port (COMx) displayed in Windows Device Manger is the COMx port that should be used when configuring the USB communications interface in the SpeedSys300 software (see 4.4 Getting started).

## D.2 How do I use a Meggitt vibro-meter® TQxxx/IQSxxx proximity measurement chain as the sensor input to a SpeedSys300 ODS301 module?

The SpeedSys300 ODS301 module is compatible with a wide range of industry-standard speed measurement chains (sensors/signal conditioners), specifically, proximity, electronic and magnetic sensors.

---

**NOTE:** The SpeedSys300 ODS301 module has three separate input interfaces for connection to different types of speed sensor but only one sensor / measurement chain and input channel can be configured and used per module at any one time.

---

For operation with a particular type of sensor / measurement chain, it is simply necessary to:

- Use the input interface connector (on the top of the module) that corresponds to the type of the sensor / measurement chain being used by the application.

---

**NOTE:** So for a Meggitt vibro-meter® TQxxx/IQSxxx proximity measurement chain, use the 2-WIRE CURRENT connector, with the following connections:  
IQSxxx -24V to ODS301 I- and IQSxxx COM to ODS301 I+.  
See Table 2-5 for further information on the 2-WIRE CURRENT connector.

---

- Configure the module for operation with the type of the sensor / measurement chain being used by the application.

In the SpeedSys300 software:

- On the Measurement tab, use Sensor type to configure the type of sensor / measurement chain, as follows:
  - 2-wire current for operation with proximity (eddy current) sensors.
  - 3-wire voltage for operation with electronic (Hall-effect) sensors.
  - 2-wire voltage for operation with magnetic (variable reluctance) sensors.

---

**NOTE:** So for a Meggitt vibro-meter® TQxxx/IQSxxx proximity measurement chain, select Sensor type: 2-wire current.

---

- On the Measurement tab, use Trigger level - current/voltage and Trigger edge to configure the trigger parameters for the sensor / measurement chain.

---

**NOTE:** So for a Meggitt vibro-meter® TQxxx/IQSxxx proximity measurement chain, select Trigger level - current: 18 mA.  
(This default value corresponds to the mid-range of the current output signal for an IQSxxx signal conditioner.)  
And configure Trigger edge to Rising or Falling as required by the application.

---

- On the Diagnostics tab, use Sensor OK current/voltage range to configure the OK check levels for the input signal, that is, the current or voltage range expected during normal operation of the sensor / measurement chain. That is, the range outside of which the SpeedSys300 ODS301 module's diagnostics (BIST) should indicate a problem.

---

**NOTE:** So for a Meggitt vibro-meter® TQxxx/IQSxxx proximity measurement chain, configure Sensor OK current range: 15.5 to 20.5 mA.  
(These default values correspond to the normal operating range of the current output signal for an IQSxxx signal conditioner – without diagnostics.)

---

When evaluating the SpeedSys300 ODS301 module or developing configurations, it can be convenient to use a signal generator to provide an input signal to the module (effectively emulating a sensor / measurement chain).

For a signal generator providing a voltage output signal:

- Use the 3-WIRE VOLTAGE connector, with the following connections:  
Sig. gen. High (+) to ODS301 SIG and Sig. gen. Low (COM/GND) to ODS301 V-.  
See Table 2-4 for further information on the 3-WIRE VOLTAGE connector.

And in the SpeedSys300 software:

- On the Measurement tab, select Sensor type: 3-wire voltage, and configure Trigger level - voltage and Trigger edge, depending on the signal generator's output.
- On the Diagnostics tab, configure Sensor OK voltage range to configure the OK check for the input signal, depending on the signal generator's output.

This is necessary to avoid module errors such as Sensor error and Bad pulse detected.

Once the connections between the Meggitt vibro-meter® TQxxx/IQSxxx proximity measurement chain and the SpeedSys300 ODS301 module are correct, the information in D.3 The Error LED on the front panel of the SpeedSys300 ODS301 module is showing RED. How do I determine the problem? can be useful in helping to diagnose problems with the configuration of the modules.

### D.3 The Error LED on the front panel of the SpeedSys300 ODS301 module is showing RED. How do I determine the problem?

The Error LED on the front panel of the SpeedSys300 ODS301 module is used to indicate problems with the module.

The Error LED shows red (continuous) to indicate a current problem with the module, that is, a problem that is occurring now.

The Error LED shows red blinking to indicate a past problem with the module, that is, a problem that occurred in the past and has not yet been acknowledged/cleared.

See 2.1 SpeedSys300 ODS301 module LEDs for further information on the behaviour of the module's LEDs.

The SpeedSys300 software can be used to help identify the source of the problem indicated by the module, as follows:

- 1- Start the SpeedSys300 software and establish communications with the SpeedSys300 ODS301 module (see 4.4 Getting started).
- 2- In the SpeedSys300 software, on the **Device status** tab, under **Error status**:
  - **Current error** provides information on any current problems.
  - **Error memory** provides information on any past problems that have not yet been acknowledged/cleared using the **Reset error memory** button/control.
- 3- For reference, in the SpeedSys300 software, on the **Event log** tab, an **Error codes summary** table lists status the error codes used by the module.

In addition, the SpeedSys300 software can be used to display what the SpeedSys300 ODS301 module is actually seeing, as follows:

- 1- Start the SpeedSys300 software and establish communications with the SpeedSys300 ODS301 module (see 4.4 Getting started).
- 2- In the SpeedSys300 software, on the **Process data** tab, under **Process data**:
  - **Current value** displays the current data values as measured and calculated by the module (for example, Speed, Acceleration and Input frequency).
  - **Speed plot** plots the current Speed value in a "trend" plot.

The Speed plot is a simple "trend" plot intended for indication only. Speed is plotted against the y-axis, which uses a fixed scale based on the module's configuration (notably the **Rated speed** from the **Measurement** tab). Time is plotted against the x-axis, which uses a fixed scale of 60 seconds.

Knowing what the SpeedSys300 ODS301 module is actually seeing (measuring) in this way, can be useful when diagnosing problems.

## D.4 I am changing/programming the configuration of my SpeedSys300 ODS301 module but am not seeing the expected changes. What is wrong?

To activate/change the configuration of a SpeedSys300 ODS301 module, the Program device settings control in the overall module information and controls window is used.

However, it is important to note that the SpeedSys300 ODS301 module and SpeedSys300 software must be operating at the Admin access level in order for the configuration to actually be activated/changed.

The User access level is the default access level, so the SpeedSys300 ODS301 module and SpeedSys300 software must be changed to the Admin access level before activating/changing the configuration of a module

---

**NOTE:** Activating a configuration on SpeedSys300 ODS301 module (that is, programming the module) is only possible when the SpeedSys300 ODS301 module and SpeedSys300 software are operating at the Admin access level.

---

If the SpeedSys300 ODS301 module and SpeedSys300 software are operating at the User access level when the Program device settings control is used, the software/system can give the impression that the module's configuration has been updated, but it will not be. See 5.10 Programming parameters for further information.

At any time, the Read device settings control in the overall module information and controls window can be used to download the configuration from a module, that is, to check the actual configuration running on a module.

## D.5 I am getting an analog output error even though I am not using this output/signal in my application. Why is this?

The SpeedSys300 ODS301 module's analog output (4 to 20 mA current loop) is one of the module's safety outputs so it is always monitored by the module in order to ensure that it is working correctly.

Accordingly, the SpeedSys300 ODS301 module always expects to see current flowing in this circuit (current loop). If it does not, then the module will detect this as a problem (error) and put the module into its safe state. In addition:

- On the front panel of the SpeedSys300 ODS301 module, the Error LED will show red.
- On the Device status tab in the SpeedSys300 software, the Error status will display an "Analog output feedback error" (Error code 00002000).

For this reason, it is important to always close the analog output circuit (loop) – even if is not being used by an application.

If the analog output is not being used, a simply and easy way to do this is to permanently connect a length of wire between the V+ and V0 pins of the SAFETY ANALOG / FREQ OUT connector, thereby short circuiting the connection (closing the loop).

Alternatively, the recommended longer-term solution is to modify the configuration of the SpeedSys300 ODS301 module as follows: on the Diagnostics tab, under Diagnostics, ensure that both Disable analog output check and Disable analog error raising are selected.

See 2.2 SpeedSys300 ODS301 module connectors for further information on the SAFETY ANALOG / FREQ OUT connector.

I am using the frequency (speed) output but cannot see an output signal. What

## D.6 I am using the frequency (speed) output but cannot see an output signal. What should I check?

The SpeedSys300 ODS301 module's frequency (speed) output features an open-collector output signal in order to support interfacing to different devices that have different operating voltage levels.

Accordingly, the frequency (speed) output signal requires a pull-up resistor connected to the required voltage level. If a pull-up resistor is not used, the frequency (speed) output will only appear as a low-level signal (of the order of 100 mV).

### Examples

When interfacing to an external system, the value of the pull-up resistor can be calculated as follows:

$$R = V / I$$

$$R_{PULL-UP} = V_{SUPPLY} / I_{MAX}$$

---

**NOTE:** The *SpeedSys300 ODS301 overspeed detection system data sheet* specifies a maximum voltage of +24 V<sub>DC</sub> and a maximum current of 100 mA for the frequency (speed) output.

---

So, when interfacing to an external +24 V<sub>DC</sub> system:

$$R_{PULL-UP (MIN)} = +24 V_{DC} / 100 mA = 240 \Omega (min.)$$

So, when interfacing to an external +5 V<sub>DC</sub> system:

$$R_{PULL-UP (MIN)} = +5 V_{DC} / 100 mA = 50 \Omega (min.)$$

In practice, 10 or 1 kΩ is often a good starting choice if you are unsure of what resistor value to try.

See 2.2 SpeedSys300 ODS301 module connectors for further information on the SAFETY ANALOG / FREQ OUT connector.

## APPENDIX E: SPEEDSYS300 ODS301 DIAGNOSTIC ERROR CODES

This section provides an overview of the SpeedSys300 ODS301 diagnostic error codes used by the SpeedSys300 software.

### E.1 Error codes

Table E-1 provides further information on the diagnostic error codes that the SpeedSys300 software can report for a SpeedSys300 ODS301 module (see 5.9 Event log tab).

**Table E-1:** SpeedSys300 ODS301 Modbus registers – error codes

Code (Hex)	Name (SpeedSys300 software)	Description
0000 0001	Non-safety parameter error	Bad CRC of parameter group 'Configuration - user' (Device tab) or bad CRC of non-volatile status. If error persists, the module must be returned to Meggitt SA.
0000 0002	Safety parameter error	Bad CRC in one or more of the following parameter groups: - Configuration – admin (Device tab) - Measurement tab - Output tab - Diagnostics tab. If error persists, the module must be returned to Meggitt SA.
0000 0004	Factory settings error	Bad CRC in one or more of the following parameter groups: - Device Configuration – factory - Diagnostics – factory - Output – factory - Default Device Configuration – user - Default Device Configuration – admin - Default Measurement - Default Diagnostics – admin - Default Output – admin If error persists, the module must be returned to Meggitt SA.
0000 0008	RAM parity error	Parity error interrupt triggered. If error persists, the module must be returned to Meggitt SA.
0000 0010	Self check failed	One or more of internal diagnostic tests failed. If error persists, the module must be returned to Meggitt SA.
0000 0020	ROM CRC error	Checksum error of internal ROM. If error persists, the module must be returned to Meggitt SA.
0000 0040	RAM check error	Checksum error of internal RAM. If error persists, the module must be returned to Meggitt SA.
0000 0080	Sensor error	Sensor error detected. The limit values entered in Diagnostics tab were exceeded.
0000 0100	Watchdog reset detected	Master MCU was reset by watchdog
0000 0200	Bad pulse detected	Non-synchronism of redundant channels detected. See 5.5 Diagnostics tab.

**Table E-1:** SpeedSys300 ODS301 Modbus registers – error codes (continued)

<b>Code (Hex)</b>	<b>Name (SpeedSys300 software)</b>	<b>Description</b>
0000 0400	Slave communication error	Communication between master and slave MCU failed
0000 0800	Comparator threshold readback error	The setting of the comparator threshold level has failed, due to a deviation of the readback value.
0000 1000	Slave supply out of range	Slave MCU supply voltage or sensor supply voltage out of range
0000 2000	Analog output readback error	Deviation of the analog output readback value from the nominal value detected. See 5.5 Diagnostics tab.
0000 4000	Rail supply out of range	Internal rail supply out of range
0000 8000	Main supply out of range	External main supply voltage out of range
0001 0000	CPU supply out of range	Master MCU supply voltage out of range
0002 0000	Relays partial stroke test failed	Cyclic operability check of the relays failed. One or more of the relays cannot be controlled as intended.
0004 0000	Parameter value out of range	Parameter values stored in internal memory are out of permissible range. If error persists, the module must be returned to Meggitt SA.
0008 0000	CPU temperature out of range	MCU temperature out of range
0010 0000	USB interface activated	Safe state activated upon connecting a USB device. For configuration, see 5.5 Diagnostics tab.
0020 0000	Initial safe state	Safe state activated upon connecting a USB device. For configuration, see 5.5 Diagnostics tab.
0040 0000	Slave UART watchdog error	The slave MCU has stopped communication, which causes the module to enter the safe state.
0080 0000	Slave runtime watchdog error	Slave MCU was reset by watchdog during normal operation
0100 0000	Slave start-up watchdog error	Slave MCU was reset by watchdog during initial self check (ROM, RAM, CPU)

## APPENDIX F: SPEEDSYS300 ODS301 MODBUS REGISTER DEFINITIONS

This section provides an overview of the SpeedSys300 ODS301 Modbus register definitions in a series of tables.

### F.1 Status and diagnostics

#### F.1.1 Main status

Table F-1 describes the SpeedSys300 ODS301 Modbus registers related to main status parameters.

---

**NOTE:** The Modbus registers in this data block are read only.

---

**Table F-1:** SpeedSys300 ODS301 Modbus registers – main status parameters

Address	Name	Data type	Range	Access	Description
0000	device_ID	uint16		R/O	Device identification code. SpeedSys300 ODS301 (SSY300 ID) is 2300.
0001	device_ver	uint16		R/O	Current firmware version
0002	ROM_CRC	uint16		R/O	Current program-ROM CRC
0003	pp_test_active	uint16		R/O	Proof test request active (digital input or Modbus register). See also Modbus register 0112 (proof_req).
0004	serial_num	uint16		R/O	Serial number. Copy of "Device config - factory" serial number.

**Table F-1:** SpeedSys300 ODS301 Modbus registers – main status parameters (continued)

Address	Name	Data type	Range	Access	Description
0012	err_status	uint32		R/O	<p>Current error status. Main error register: B0 – Non-safety parameter CRC B1 – Safety parameter CRC B2 – Factory parameter CRC B3 – Parity error interrupt B4 – Self check (see Modbus register 6513 (exec error)) B5 – ROM CRC check B6 – RAM check B7 – Sensor error (short/break) B8 – Watchdog trigger B9 – Bad pulse B10 – Slave communication failed B11 – Slave threshold readback B12 – Slave supplies B13 – Aout readback error B14 – Rail supply out of range B15 – 24 V supply out of range B16 – Master Vcc out of range B17 – Relay PST error B18 – Parameter value invalid B19 – Master temperature over/under range B20 – USB interface active B21 – Initial safe B22 – UART watchdog B23 – Slave runtime watchdog error B24 – Slave start-up watchdog error B25-B31 – n.u.</p>
0014	access_level	uint16		R/O	<p>Current access level: 0 – User 1 – Admin 2 – Factory.</p>
0015	prog_state	uint16		R/O	<p>Programming status. B7-B0: 0 – normal operating mode 1 – parameters programming mode in progress. B15-B8: Last successfully executed command code or 0xFF in case of command execution error.</p>

**Table F-1: SpeedSys300 ODS301 Modbus registers – main status parameters (continued)**

Address	Name	Data type	Range	Access	Description
0016	param_chk_result	uint16		R/O	Result of check of Parameters ranges. Bitwise coded. Bit set means "Parameters out of range" or block CRC incorrect: B0 – Device config - user B1 – Device config - admin B2 – Device config - factory B3 – Measurement config B4 – Diagnostics - admin B5 – Diagnostics - factory B6 – Output - admin B7 – Output - factory B8 – Admin password B9 – Device config - user (default settings) B10 – Device config - admin (default settings) B11 – Measurement config (default settings) B12 – Output - admin (default settings).
0017	safe_state	uint16		R/O	Value 1 signals module in safe state
0018	power_on_time	uint32		R/O	Time elapsed since last power cycle
0020	total_work	uint32		R/O	Total power on time since factory release
0022	CPU_temperature	single		R/O	Current master MCU temperature
0024	err_status_mem	uint32		R/O	Error status memory. Read/write for each access level.

## F.1.2 Control

Table F-2 describes the SpeedSys300 ODS301 Modbus registers related to control parameters.

**NOTE:** The Modbus registers in this data block are read only.

**Table F-2:** SpeedSys300 ODS301 Modbus registers – control parameters

Address	Name	Data type	Range	Access	Description
0100	access_pass	char16		Level 0	Writing this register controls the access level to the module. Read/write for each access level. Writing string equal to parameter "admin pass" grants admin-level access (see also Modbus register 1000 (admin_pass)). Writing factory password grants factory-level access (if factory access jumper is closed). Writing other value sets user-level access.
0108	prog_mode	uint16		Level 0	Programming mode setting command. Read/write for each access level. Code 0x33 – Enter parameter programming mode. Code 0x55 – Restore admin default. Code 0x66 – Save current as default. Code 0x77 – Restore current settings. Code 0xAA – Save settings.
0109	PWM_output	uint16		Level 2	Current value of PWM-setting for analog output. Read/write for factory-level access. Used for factory output calibration.
0110	output_disable	uint16		Level 2	Disable updating "Pwm output" by output routine. Read/write for factory-level access. Setting value 1 in this object disables output control routine to update analog output. It makes possible to use "PWM output" object for analog output calibration.
0111	diag_cmd	uint16		Level 0	Diagnostic command. Read/write for each access level. Writing 1 to: B0 – Resets min/max values of "min rpm" and "max rpm", "min acc" and "max acc". B1 – Resets system error memory B2 – Resets loop exec times B3 – Reset slave error memory B4 – Reset event log (factory-level access required).
0112	proof_req	uint16		Level 0	B0 - Simulate digital input "Proof test". Read/write for each access level.

### F.1.3 Current values

Table F-3 describes the SpeedSys300 ODS301 Modbus registers related to current value parameters, that is, the Modbus registers to be used to obtain the current (“live”) values from a module.

**NOTE:** The Modbus registers in this data block are read only.

**Table F-3:** SpeedSys300 ODS301 Modbus registers – Current values

Address	Name	Data type	Range	Access	Description
0500	curr_rpm	single		R/O	Current velocity [RPM]
0502	curr_freq	single		R/O	Current acceleration [RPM/s]
0504	curr_base	single		R/O	Current input frequency used as base for velocity calculation [Hz]
0506	curr_acc_freq	single		R/O	Current input frequency used for acceleration calculation [Hz]
0508	curr_acc_base	single		R/O	Current acceleration [Hz/s]. Used as base for RPM/s calculation.
0510	curr_aout	single		R/O	Current analog output value [mA]
0512	curr_aout_fb	single		R/O	Current analog output feedback value [mA]
0514	max_rpm	single		R/O	Max. velocity value registered since power up or min/max reset (see Modbus register 0111 (diag_cmd)) [RPM]
0516	min_rpm	single		R/O	Min. velocity value registered since power up or min/max reset (see Modbus register 0111 (diag_cmd)) [RPM]
0518	max_acc	single		R/O	Max. acceleration value registered since power up or min/max reset (see Modbus register 0111 (diag_cmd)) [RPM/s]
0520	min_acc	single		R/O	Min. acceleration value registered since power up or min/max reset (see Modbus register 0111 (diag_cmd)) [RPM/s]
0522	master_vcc	single		R/O	Current value of master Vcc voltage [V]
0524	v_rail	single		R/O	Current value of rail voltage [V]
0526	v_supl	single		R/O	Current value of main supply voltage [V]
0528	CPU_temp	single		R/O	Current master MCU temperature [°C]
0530	slave_vcc	single		R/O	Average slave MCU Vcc value within last 50 ms [V]
0532	slave_vcc_max	single		R/O	Max. slave MCU Vcc value within last 50 ms [V]
0534	slave_vcc_min	single		R/O	Min. slave MCU Vcc value within last 50 ms [V]

**Table F-3:** SpeedSys300 ODS301 Modbus registers – Current values (continued)

Address	Name	Data type	Range	Access	Description
0536	slave_suppl_max	single		R/O	Max. slave sensor supply voltage within last 50 ms [V]
0538	slave_suppl_min	single		R/O	Min. slave sensor supply voltage within last 50 ms [V]
0540	slave_i1_max	single		R/O	Max. sensor current (path 1) within last 50 ms [mA]
0542	slave_i1_min	single		R/O	Min. sensor current (path 1) within last 50 ms [mA]
0544	slave_i2_max	single		R/O	Max. sensor current (path 2) within last 50 ms [mA]
0546	slave_i2_min	single		R/O	Min. sensor current (path 2) within last 50 ms [mA]
0548	slave_v1_max	single		R/O	Max. sensor voltage (path 1) within last 50 ms [V]
0550	slave_v1_min	single		R/O	Min. sensor voltage (path 1) within last 50 ms [V]
0552	slave_v2_max	single		R/O	Max. sensor voltage (path 2) within last 50 ms [V]
0554	slave_v2_min	single		R/O	Min. sensor voltage (path 2) within last 50 ms [V]
0556	pp_test_stat	uint16		R/O	Partial proof test input status: 1 – input active, 0 – inactive
0557	al_Rel1_active	uint16		R/O	Active alarms for relay 1. Bitwise coded as follows: B0 – n.u. B1 – n.u. B2 – Overspeed B3 – Underspeed B4 – Acceleration max. B5 – Acceleration min. B6 – Self check B7 – Partial proof test B8 – Non-safety error.
0558	al_Rel2_active	uint16		R/O	Active alarms for relay 2. Bitwise coded as per active alarms for relay 1 (see Modbus register 0557 (al_Rel1_active)).
0559	al_Rel3_active	uint16		R/O	Active alarms for relay 3. Bitwise coded as per active alarms for relay 1 (see Modbus register 0557 (al_Rel1_active)).
0560	al_Rel4_active	uint16		R/O	Active alarms for relay 4. Bitwise coded as per active alarms for relay 1 (see Modbus register 0557 (al_Rel1_active)).
0561	al_dout_active	uint16		R/O	Active alarms for digital output. Bitwise coded as per active alarms for relay 1 (see Modbus register 0557 (al_Rel1_active)).

**Table F-3:** SpeedSys300 ODS301 Modbus registers – Current values (continued)

Address	Name	Data type	Range	Access	Description
0562	dout_stat	uint16		R/O	Digital outputs status. Output bitwise coded. Bit set means “output active”: B0 – Relay 1 B1 – Relay 2 B2 – Relay 3 B3 – Relay 4 B4 – Digital output.
0563	reserved	uint16		R/O	
0564	freq_2_curr	single		R/O	Current frequency measured on second pulse input (auxiliary frequency measurement) [Hz]
0566	freq_2_max	single		R/O	Max. auxiliary frequency value registered since power up or min/max reset (see Modbus register 0111 (diag_cmd)) [Hz]
0568	freq_2_min	single		R/O	Min. auxiliary frequency value registered since power up or min/max reset (see Modbus register 0111 (diag_cmd)) [Hz]

### F.1.4 Diagnostics data

Table F-4 describes the SpeedSys300 ODS301 Modbus registers related to diagnostics data.

**NOTE:** The Modbus registers in this data block are read only.

**Table F-4:** SpeedSys300 ODS301 Modbus registers – diagnostics data values

Address	Name	Data type	Range	Access	Description
6500	ram_chk_cnt	uint32		R/O	Ram check counter. Incremented each time ram check complete.
6502	last_chk_pulses	uint32		R/O	Reference clock pulses encountered in last second
6504	aout_chk_diff	single		R/O	Difference between analog output value and analog output readback
6506	fram_read_stat	uint32		R/O	FRAM read status (CRC bad). Bitwise coded: B0 – 1st copy of 'Device config - user' B1 – 2nd copy of 'Device config - user' B2 – 1st copy of 'Device config - admin' B3 – 2nd copy of 'Device config - admin' B4 – 1st copy of 'Device config - factory' B5 – 2nd copy of 'Device config - factory' B6 – 1st copy of 'Measurement config' B7 – 2nd copy of 'Measurement config' B8 – 1st copy of 'Diag config - admin' B9 – 2nd copy of 'Diag config - admin' B10 – 1st copy of 'Diag config - factory' B11 – 2nd copy of 'Diag config - factory' B12 – 1st copy of 'Output config - admin' B13 – 2nd copy of 'Output config - admin' B14 – 1st copy of 'Output config - factory' B15 – 2nd copy of 'Output config - factory' B16 – 1st copy of 'Admin pass' B17 – 2nd copy of 'Admin pass' B18 – Factory setting for 'Device config - user' B19 – Factory setting for 'Device config - admin' B20 – Factory setting for 'Measurement config' B21 – Factory setting for 'Diagnostic config - admin' B22 – Factory setting for 'Output config - admin' B23 – 1st copy of NV-status B24 – 2nd copy of NV-status.
6508	mloop_avr_tm	uint32		R/O	Average main loop time [ns]
6510	mloop_min_tm	uint16		R/O	Min. main loop time [μs]
6511	mloop_max_ignored	uint16		R/O	Max. main loop time for cycles with FRAM access (ignored for error time check) [μs]
6512	mloop_max_tm	uint16		R/O	Max. main loop time for standard cycles [μs]

**Table F-4: SpeedSys300 ODS301 Modbus registers – diagnostics data values (continued)**

Address	Name	Data type	Range	Access	Description
6513	exec_error	uint16		R/O	Execution error status. Bitwise coded: B0 – Execution completion error B1 – Assertion error B2 – Stack Overrun B3 – Interrupt error B4 – Main loop time exceeded B5 – MCU check error B6 – Acceleration calculation error B7 – Frequency calculation error B8 – MCU clock err.
6514	slv_assert_err	uint32		R/O	Slave assert error address
6516	slv_err_stat	uint16		R/O	Slave error status. Bitwise coded: B0 – ROM CRC error B1 – RAM-check error B2 – MCU-check error B3 – General execution error (see B8-B15) B4 – A/D not ready B5-B7 – n.u. B8 – Execution completion error B9 – Assertion error B10 – Stack overrun B11 – Interrupt check error B12 – Max. main loop time override B13-B15 – n.u.
6517	slv_rom_crc	uint16		R/O	Slave ROM CRC. Updated only in slave error response. Value 0 means no slave errors.
6518	slv_mloop_tm	uint16		R/O	Slave main loop time [µs]. Updated only in slave error response. Value 0 means no slave errors.
6519	slv_com_err	uint16		R/O	Slave communication error. Bitwise coded: B0 – n.u. B1 – Message counter mismatch B2 – Message CRC error B3 – Message format error B4 – Context error (response w/o request) B5 – Slave internal error (slave diagnostics).
6520	slv_com_err_mem	uint16		R/O	Slave communication error memory
6521	ma_fb_raw	uint16		R/O	Current output feedback raw value
6522	raw_ad_in_1	uint16		R/O	Internal A/D convertor raw input for main supply (24 V)
6523	raw_ad_in_2	uint16		R/O	Internal A/D convertor raw input for rail supply
6524	raw_ad_in_3	uint16		R/O	Internal A/D convertor raw input for MCU V <sub>cc</sub>
6525	raw_ad_in_4	uint16		R/O	Internal A/D convertor raw input for MCU temperature measurement
6526	t_calib	uint32		R/O	MCU temperature calibration factor

**Table F-4:** SpeedSys300 ODS301 Modbus registers – diagnostics data values (continued)

Address	Name	Data type	Range	Access	Description
6528	pulse_count_a	uint32		R/O	Pulse count on input a
6530	pulse_count_b	uint32		R/O	Pulse count on input b
6532	calc_count_eval_f	uint32		R/O	Count of evaluated frequency calculation
6534	calc_count_eval_a	uint32		R/O	Count of evaluated acceleration calculation
6536	calc_count_est_f	uint32		R/O	Count of estimated frequency calculation
6538	calc_count_est_a	uint32		R/O	Count of estimated acceleration calculation
6540	assert_err	uint32		R/O	Master assert error address

## F.1.5 Slave communication status

Table F-5 describes the SpeedSys300 ODS301 Modbus registers related to slave communication status parameters.

**NOTE:** The Modbus registers in this data block are read only.

**Table F-5:** SpeedSys300 ODS301 Modbus registers – slave communication status values

Address	Name	Data type	Range	Access	Description
7000	resp_msg_cnt	uint16		R/O	Slave response - message counter
7001	event_stat	uint16		R/O	B8 – watchdog trigger detected B9 – communication error occurred B9 – A/D convertor not ready
7002	measure_cmd_fb	uint16		R/O	Command feedback: B0, B1 – key selector
7003	cpu_temperature	uint16		R/O	Slave MCU temperature. Unit: °C.
7004	min_ad_1	uint16		R/O	Min. value of A/D raw input 1 (I-monitor 1)
7005	min_ad_2	uint16		R/O	Min. value of A/D raw input 2 (V-monitor 1)
7006	min_ad_3	uint16		R/O	Min. value of A/D raw input 3 (A/D feedback 1)
7007	min_ad_4	uint16		R/O	Min. value of A/D raw input 4 (I-monitor 2)
7008	min_ad_1	uint16		R/O	Min. value of A/D raw input 5 (V-monitor 2)
7009	min_ad_6	uint16		R/O	Min. value of A/D raw input 6 (D/A feedback 2)
7010	min_ad_7	uint16		R/O	Min. value of A/D raw input 7 (V-ref)
7011	min_ad_8	uint16		R/O	Min. value of A/D raw input 8 (Vcc)
7012	max_ad_1	uint16		R/O	Max. value of A/D raw input 1 (I-monitor 1)
7013	max_ad_2	uint16		R/O	Max. value of A/D raw input 2 (V-monitor 1)
7014	max_ad_3	uint16		R/O	Max. value of A/D raw input 3 (A/D feedback 1)
7015	max_ad_4	uint16		R/O	Max. value of A/D raw input 4 (I-monitor 2)
7016	max_ad_5	uint16		R/O	Max. value of A/D raw input 5 (V-monitor 2)
7017	max_ad_6	uint16		R/O	Max. value of A/D raw input 6 (D/A feedback 2)
7018	max_ad_7	uint16		R/O	Max. value of A/D raw input 7 (V-ref)
7019	max_ad_8	uint16		R/O	Max. value of A/D raw input 8 (Vcc)
7020	smp_count	uint16		R/O	Number of samples in request period
7021	slave_rom_crc	uint16		R/O	Slave ROM CRC
7022	req_msg_cnt	uint16		R/O	Slave request message counter

**Table F-5:** SpeedSys300 ODS301 Modbus registers – slave communication status values (continued)

Address	Name	Data type	Range	Access	Description
7023	measure_cmd	uint16		R/O	Measurement command: B0, B1 – key selector
7024	da_out_1	uint16		R/O	Requested D/A output value for output 1
7025	da_out_2	uint16		R/O	Requested D/A output value for output 2

## F.2 Parameters and configuration settings

When a SpeedSys300 ODS301 module is in the normal operating mode (access level: User / Device status: Operating), the work parameter set is accessed in read only mode.

When a SpeedSys300 ODS301 module is in the parameter programming mode (access level: Admin / Device status: Programming – safe state), the work parameter set is accessed in read/write mode.

The Password – admin area is not available at the User access level in order to help prevent unauthorized access to the admin password string. See 4.6.1 Changing the Admin access level password for further information.

It is important to note that in the parameter programming mode, write access further depends on the access level setting (User, Admin or Factory), which is controlled by “access pass” (Modbus register 0100).

Write access is only possible using the SpeedSys300 software via the USB serial interface.

### F.2.1 Admin password

Table F-6 describes the SpeedSys300 ODS301 Modbus registers related to the admin password.

This data block is accessible only while access level 1 (admin) or level 2 (factory) is granted. For access level 0 (user) read and write function is rejected.

---

**NOTE:** The Modbus registers in this data block are read/write.

---

**Table F-6:** SpeedSys300 ODS301 Modbus registers – admin password

Address	Name	Data type	Range	Access	Description
1000	admin_pass	char16		Level 1	Admin password
1008	reserve	uint16		Level 1	
1009	crc_pass_adm	uint16		Level 1	Parameter block CRC

### F.2.2 Device configuration – user

Table F-7 describes the SpeedSys300 ODS301 Modbus registers related to the module configuration – user.

---

**NOTE:** The Modbus registers in this data block are read/write.

---

**Table F-7:** SpeedSys300 ODS301 Modbus registers – module configuration – user

Address	Name	Data type	Range	Access	Description
2000	tag_1	char16		Level 0	
2008	tag_2	char16		Level 0	
2016	tag_3	char16		Level 0	
2024	dev_comment	char32		Level 0	
2040	modbus_addr	uint16	1 to 254	Level 0	Modbus address for RS-485 interface
2041	baud_rs485	uint16	0 to 5	Level 0	Coded baud rate for RS-485 interface: 0 – 4800 1 – 9600 2 – 19200 3 – 38400 4 – 57600 5 – 115200.
2042	reserve	uint16		Level 0	
2043	parity_rs485	uint16	0 to 2	Level 0	0 – no parity, 1 – even parity, 2 – odd parity
2044	rs485_term	uint16	0 to 1	Level 0	0 – RS-485 termination off, 1 – on
2045	crc_dev_user	uint16		Level 0	Parameter block CRC

### F.2.3 Device configuration – admin

Table F-8 describes the SpeedSys300 ODS301 Modbus registers related to the module configuration – admin.

**NOTE:** The Modbus registers in this data block are read/write.

**Table F-8:** SpeedSys300 ODS301 Modbus registers – module configuration – admin

Address	Name	Data type	Range	Access	Description
2500	tag_1_adm	char16		Level 1	
2508	tag_2_adm	char16		Level 1	
2516	tag_3_adm	char16		Level 1	
2524	dev_comment_adm	char32		Level 1	
2540	voting_struct	uint16		Level 1	Voting structure - only for reporting. (For information only.)
2541	crc_dev_adm	uint16		Level 1	Parameter block CRC

## F.2.4 Device configuration – factory

Table F-9 describes the SpeedSys300 ODS301 Modbus registers related to the module configuration – factory.

This data block is intended/reserved for factory use only and should not be changed by end-users.

---

**NOTE:** The Modbus registers in this data block are read/write.

---

**Table F-9:** SpeedSys300 ODS301 Modbus registers – module configuration – factory

Address	Name	Data type	Range	Access	Description
3000	serial_number	char16		Level 2	
3008	schem_version	char16		Level 2	
3016	PCB_code	char16		Level 2	
3024	device_option	uint16		Level 2	Module personality (bit pattern): 0010b – SpeedSys200 0011b – SpeedSys300 ODS301.
3025	crc_dev_fact	uint16		Level 2	Parameter block CRC

## F.2.5 Measurement configuration

Table F-10 describes the SpeedSys300 ODS301 Modbus registers related to the module measurement configuration.

---

**NOTE:** The Modbus registers in this data block are read/write.

---

**Table F-10:** SpeedSys300 ODS301 Modbus registers – measurement configuration

Address	Name	Data type	Range	Access	Description
4000	wheel_shape	uint16	0 to 3	Level 1	Type of wheel. (For information only.)
4001	wheel_teeth	uint16	1 to 10000	Level 1	Number of pulses per revolution
4002	sensor_type	uint16	0 to 2	Level 1	Sensor type: 0 – 2-wire current 1 – 3-wire voltage 2 – 2-wire voltage.
4003	freq_avr	uint16	1 to 1000	Level 1	Frequency averaging window for frequency measurement
4004	freq_avr_acc	uint16	1 to 1000	Level 1	Frequency averaging window for acceleration measurement

**Table F-10:** SpeedSys300 ODS301 Modbus registers – measurement configuration (continued)

Address	Name	Data type	Range	Access	Description
4005	acc_depth	uint16	1 to 5000	Level 1	Acceleration calculation depth, used when 'acc_d_factor' = 0. (See also Modbus register 4006 (acc_d_factor)).
4006	acc_d_factor	uint16	0 to 1000	Level 1	Acceleration calculation depth factor. Define frequency dependent acceleration calculation $Depth = f/Acc\ d\ factor$ . Factor value = 0 means fixed calculation depth is to apply (param.: 'Acc depth'). For example, a factor value of 100 means for current frequency 20000 Hz, acceleration calculation depth is 200. (See also Modbus register 4005 (acc_depth)).
4007	meas_mode	uint16		Level 1	Info field – only for reporting. (For information only.)
4008	rated_speed	single	0 to 2100000	Level 1	Nominal speed Range defined in 'Output config - factory'
4010	trig_level_I	single	0 to 20.5	Level 1	Trigger level for current input
4012	trig_level_U	single	0 to 24	Level 1	Trigger level for voltage input
4014	meas_edge	uint16	0 to 1	Level 1	Measurement edge: 0 – Rising edge 1 – Falling edge.
4015	module	uint16		Level 1	Info field – only for reporting. (For information only.)
4016	low_freq_cut	single	0 to 35000	Level 1	Minimum frequency value for sensor measurement activation (low frequency cutoff)
4018	reserve	uint16		Level 1	
4019	crc_mesurement	uint16		Level 1	Parameter block CRC

## F.2.6 Diagnostics configuration – admin

Table F-11 describes the SpeedSys300 ODS301 Modbus registers related to the module diagnostics configuration – admin.

**NOTE:** The Modbus registers in this data block are read/write.

**Table F-11:** SpeedSys300 ODS301 Modbus registers – diagnostics configuration – admin

Address	Name	Data type	Range	Access	Description
4500	bad_pulse_cnt	uint32	bp_tout_min to bp_tout_max	Level 1	Count-out for bad pulses: Min. count of good pulses per one bad pulse. Value 0 causes each bad pulse to immediately raise a diagnostic error. Range defined in 'Diag config - factory'
4502	max_sens_l	single	i_sens_min to i_sens_max	Level 1	Max. sensor current Range defined in 'Diag config - factory'
4504	min_sens_l	single	i_sens_min to i_sens_max	Level 1	Min. sensor current Range defined in 'Diag config - factory'
4506	max_sens_u	single	v_sens_min to v_sens_max	Level 1	Max. sensor voltage Range defined in 'Diag config - factory'
4508	min_sens_u	single	v_sens_min to v_sens_max	Level 1	Min. sensor voltage Range defined in 'Diag config - factory'
4510	aout_chk	single	aout_chk_min to aout_chk_max	Level 1	Analog output readback difference [mA] Range defined in 'Diag config - factory'

**Table F-11:** SpeedSys300 ODS301 Modbus registers – diagnostics configuration – admin (continued)

Address	Name	Data type	Range	Access	Description
4512	e_latch_mask_adm	uint32		Level 1	<p>Error latching mask. Bit set means SpeedSys300 ODS301 stays in safe state even if error reason vanishes:</p> <p>B0 – User level 0 parameter CRC            B1 – User level 1 parameter CRC            B2 – User level 2 parameter CRC            B3 – n.u.            B4 – n.u.            B5 – n.u.            B6 – n.u.            B7 – Sensor error (short/break)            B8 – n.u.            B9 – Bad pulses            B10 – Slave communication failed            B11 – Threshold readback error            B12 – Slave supplies            B13 – Aout readback error            B14 – Rail supply out of range            B15 – 24 V supply out of range            B16 – Master Vcc out of range            B17 – Relay PST error            B18 – Parameter value invalid            B19 – Master temperature over/under range            B20 – USB interface active            B21 – n.u. (initial safe always latching)            B22 – UART watchdog            B23 – Slave runtime watchdog error            B24 – Slave startup watchdog error            B25-B31 – n.u.</p> <p>This mask is OR-ed with corresponding mask in factory diagnostic parameter set.</p>
4514	proof_chk	uint16	0 to 1	Level 1	<p>Proof check active:</p> <p>0 – Not active (only error reset)            1 – Active (proof check and error reset).</p>
4515	USB_active	uint16	0 to 1	Level 1	<p>USB activate action:</p> <p>0 – No action            1 – Enter safe state (error bit B20).</p>
4516	sif_disable	uint16		Level 1	<p>B0 – Disable analog output check            B1 – Disable analog output error signalling (no err_our in safe state)            B2 – Disable initial safe state after power cycle or watchdog reset.</p>
4517	crc_diag_adm	uint16		Level 1	Parameter block CRC

## F.2.7 Diagnostics configuration – factory

Table F-12 describes the SpeedSys300 ODS301 Modbus registers related to the module diagnostics configuration – factory.

**NOTE:** This data block is intended/reserved for factory use only and should not be changed by end-users.

**NOTE:** The Modbus registers in this data block are read/write.

**Table F-12:** SpeedSys300 ODS301 Modbus registers – diagnostics configuration – factory

Address	Name	Data type	Range	Access	Description
5000	slv_u_ref	single	2.4 to 2.6	Level 2	Reference voltage value (slave) [V]
5002	slv_vcc_max	single	3.3 to 3.8	Level 2	Slave Vcc voltage maximum limit
5004	slv_vcc_min	single	3.0 to 3.3	Level 2	Slave Vcc voltage minimum limit
5006	supl_sens_max	single	12 to 30	Level 2	Max. value of sensor supply voltage (slave)
5008	supl_sens_min	single	12 to 30	Level 2	Min. value of sensor supply voltage (slave)
5009	u_diff_thrs	uint16	0 to 4095	Level 2	Threshold voltage readback difference. Abs. value in A/D readings digits (slave).
5011	reserve	uint16		Level 2	
5012	m_u_ref	single	2.4 to 2.6	Level 2	Master reference voltage
5014	m_vcc_max	single	3.3 to 3.8	Level 2	Master Vcc voltage maximum limit
5016	m_vcc_min	single	3.0 to 3.3	Level 2	Master Vcc voltage minimum limit
5018	rail_u_max	single	12 to 16	Level 2	Supply rail voltage maximum (master)
5020	rail_u_min	single	9 to 12	Level 2	Supply rail voltage minimum (master)
5022	u_24v_max	single	24 to 40	Level 2	24 V supply voltage maximum (master)
5024	u_24v_min	single	10 to 24	Level 2	24 V supply voltage minimum (master)

**Table F-12:** SpeedSys300 ODS301 Modbus registers – diagnostics configuration – factory (continued)

Address	Name	Data type	Range	Access	Description
5026	e_latch_mask	uint32		Level 2	<p>Error latching mask. Bit set means SpeedSys300 ODS301 stays in safe state even if error reason vanishes:</p> <ul style="list-style-type: none"> <li>B0 – User level 0 parameter CRC</li> <li>B1 – User level 1 parameter CRC</li> <li>B2 – User level 2 parameter CRC</li> <li>B3 – n.u.</li> <li>B4 – n.u.</li> <li>B5 – n.u.</li> <li>B6 – n.u.</li> <li>B7 – Sensor error (short/break)</li> <li>B8 – n.u.</li> <li>B9 – Bad pulses</li> <li>B10 – Slave communication failed</li> <li>B11 – Threshold readback error</li> <li>B12 – Slave supplies</li> <li>B13 – Aout readback error</li> <li>B14 – Rail supply out of range</li> <li>B15 – 24 V supply out of range</li> <li>B16 – Master Vcc out of range</li> <li>B17 – Relay PST error</li> <li>B18 – Parameter value invalid</li> <li>B19 – Master temperature over/under range</li> <li>B20 – USB interface active</li> <li>B21 – n.u. (initial safe always latching)</li> <li>B22 – UART watchdog</li> <li>B23 – Slave runtime watchdog error</li> <li>B24 – Slave startup watchdog error</li> <li>B25-B31 – n.u.</li> </ul>
5028	e_reset_mask	uint32		Level 2	<p>Error reset mask. Bit set means in case of error SpeedSys300 ODS301 resets itself (stops watchdog retrigger). Bit not set means it stays in safe state until power cycle:</p> <ul style="list-style-type: none"> <li>B0 – n.u.</li> <li>B1 – n.u.</li> <li>B2 – n.u.</li> <li>B3 – Parity error</li> <li>B4 – ROM check CRC</li> <li>B5 – RAM check</li> <li>B6 – Self check</li> <li>B7 – n.u.</li> <li>B8 – n.u.</li> <li>B9 – n.u.</li> <li>B10 – n.u.</li> <li>B11 – n.u.</li> <li>B12 – n.u.</li> <li>B13 – n.u.</li> <li>B14 – n.u.</li> <li>B15 – n.u.</li> <li>B16 – n.u.</li> <li>B17 – n.u.</li> <li>B18 – n.u.</li> <li>B19-B31 – n.u.</li> </ul>

**Table F-12: SpeedSys300 ODS301 Modbus registers – diagnostics configuration – factory (continued)**

Address	Name	Data type	Range	Access	Description
5030	aout_chk_max	single	0.02 to 20	Level 2	Max. value of Aout readback error
5032	aout_chk_min	single	0.02 to 20	Level 2	Min. value of Aout readback error
5034	i_sens_max	single	0 to 30	Level 2	Max. value of sensor current limit setting
5036	i_sens_min	single	0 to 30	Level 2	Min. value of sensor current limit setting
5038	v_sens_max	single	0 to 24	Level 2	Max. value of sensor voltage limit setting
5040	v_sens_min	single	0 to 10	Level 2	Min. value of sensor voltage limit setting
5042	temp_max	single	-40 to 120	Level 2	Max. value of MCU temperature
5044	temp_min	single	-40 to 120	Level 2	Min. value of MCU temperature
5046	bp_tout_max	uint32	0 to 2000000000	Level 2	Max. value of bad pulse time-out setting. Unit: 1 ms. Value 0 is always allowed.
5048	bp_tout_min	uint32	0 to 2000000000	Level 2	Min. value of bad pulse time-out setting. Unit: 1 ms.
5050	sens_break_lim	single	0.0 to 6.0	Level 2	Sensor break limit for 2-wire voltage sensor [V]
5052	sens_u_offset	single	0.0 to 6.0	Level 2	Sensor reference offset for 2-wire voltage sensor [V]. (For information only.)
5054	reserve	uint16		Level 2	
5055	crc_diag_fact	uint16		Level 2	Parameter block CRC

## F.2.8 Output configuration – admin

Table F-13 describes the SpeedSys300 ODS301 Modbus registers related to the module output configuration – admin.

**NOTE:** The Modbus registers in this data block are read/write.

**Table F-13:** SpeedSys300 ODS301 Modbus registers – output configuration – admin

Address	Name	Data type	Range	Access	Description
5500	rel1_config	uint16		Level 1	Relay 1 (SIL) status: B0 – Latching B1 – n.u. B2 – Overspeed B3 – Underspeed B4 – Acceleration max. B5 – Acceleration min. B6 – n.u. B7 – Proof test B8 – Non-safety error.
5501	rel2_config	uint16		Level 1	Relay 2 (SIL) status: B0 – Latching B1 – n.u. B2 – Overspeed B3 – Underspeed B4 – Acceleration max. B5 – Acceleration min. B6 – n.u. B7 – Proof test B8 – Non-safety error.
5502	rel3_config	uint16		Level 1	Relay 3 (non-SIL) status: B0 – Latching B1 – Inverted B2 – Overspeed B3 – Underspeed B4 – Acceleration max. B5 – Acceleration min. B6 – Self diagnostics B7 – Proof test B8 – Non-safety error.
5503	rel4_config	uint16		Level 1	Relay 4 (non-SIL) status: B0 – Latching B1 – Inverted B2 – Overspeed B3 – Underspeed B4 – Acceleration max. B5 – Acceleration min. B6 – Self diagnostics B7 – Proof test B8 – Non-safety error.

**Table F-13: SpeedSys300 ODS301 Modbus registers – output configuration – admin (continued)**

Address	Name	Data type	Range	Access	Description
5504	dout_config	uint16		Level 1	Digital output (non-SIL) status: B0 – Latching B1 – Inverted B2 – Overspeed B3 – Underspeed B4 – Acceleration max. B5 – Acceleration min. B6 – Self diagnostics B7 – Proof test B8 – Non-safety error.
5505	reserve	uint16		Level 1	
5506	r1_one_shot_tm	uint32	1 to 1000000	Level 1	Relay 1 one-shot time. Unit: 1 ms.
5508	r2_one_shot_tm	uint32	1 to 1000000	Level 1	Relay 2 one-shot time. Unit: 1 ms.
5510	r3_one_shot_tm	uint32	1 to 1000000	Level 1	Relay 3 one-shot time. Unit: 1 ms.
5512	r4_one_shot_tm	uint32	1 to 1000000	Level 1	Relay 4 one-shot time. Unit: 1 ms.
5514	do_one_shot_tm	uint32	1 to 1000000	Level 1	Digital out one-shot time. Unit: 1 ms.
5516	r1_del_sp_max	uint32	0 to 1000000	Level 1	Relay 1 delay for overspeed alarm. Unit: 1 ms.
5518	r2_del_sp_max	uint32	0 to 1000000	Level 1	Relay 2 delay for overspeed alarm. Unit: 1 ms.
5520	r3_del_sp_max	uint32	0 to 1000000	Level 1	Relay 3 delay for overspeed alarm. Unit: 1 ms.
5522	r4_del_sp_max	uint32	0 to 1000000	Level 1	Relay 4 delay for overspeed alarm. Unit: 1 ms.
5524	do_del_sp_max	uint32	0 to 1000000	Level 1	Digital out delay for overspeed alarm. Unit: 1 ms.
5526	r1_del_sp_min	uint32	0 to 1000000	Level 1	Relay 1 delay for underspeed alarm. Unit: 1 ms.
5528	r2_del_sp_min	uint32	0 to 1000000	Level 1	Relay 2 delay for underspeed alarm. Unit: 1 ms.
5530	r3_del_sp_min	uint32	0 to 1000000	Level 1	Relay 3 delay for underspeed alarm. Unit: 1 ms.
5532	r4_del_sp_min	uint32	0 to 1000000	Level 1	Relay 4 delay for underspeed alarm. Unit: 1 ms.
5534	do_del_sp_min	uint32	0 to 1000000	Level 1	Digital out delay for underspeed alarm. Unit: 1 ms.

**Table F-13:** SpeedSys300 ODS301 Modbus registers – output configuration – admin (continued)

Address	Name	Data type	Range	Access	Description
5536	r1_del_acc_max	uint32	0 to 1000000	Level 1	Relay 1 delay for max. acceleration alarm. Unit: 1 ms.
5538	r2_del_acc_max	uint32	0 to 1000000	Level 1	Relay 2 delay for max. acceleration alarm. Unit: 1 ms.
5540	r3_del_acc_max	uint32	0 to 1000000	Level 1	Relay 3 delay for max. acceleration alarm. Unit: 1 ms.
5542	r4_del_acc_max	uint32	0 to 1000000	Level 1	Relay 4 delay for max. acceleration alarm. Unit: 1 ms.
5544	do_del_acc_max	uint32	0 to 1000000	Level 1	Digital out delay for max. acceleration alarm. Unit: 1 ms.
5546	r1_del_acc_min	uint32	0 to 1000000	Level 1	Relay 1 delay for min. acceleration alarm. Unit: 1 ms.
5548	r2_del_acc_min	uint32	0 to 1000000	Level 1	Relay 2 delay for min. acceleration alarm. Unit: 1 ms.
5550	r3_del_acc_min	uint32	0 to 1000000	Level 1	Relay 3 delay for min. acceleration alarm. Unit: 1 ms.
5552	r4_del_acc_min	uint32	0 to 1000000	Level 1	Relay 4 delay for min. acceleration alarm. Unit: 1 ms.
5554	do_del_acc_min	uint32	0 to 1000000	Level 1	Digital out delay for min. acceleration alarm. Unit: 1 ms.
5556	r1_sp_max	single	v_min to v_max	Level 1	Relay 1 overspeed alarm value. Range defined in 'Output config - factory'.
5558	r2_sp_max	single	v_min to v_max	Level 1	Relay 2 overspeed alarm value. Range defined in 'Output config - factory'.
5560	r3_sp_max	single	v_min to v_max	Level 1	Relay 3 overspeed alarm value. Range defined in 'Output config - factory'.
5562	r4_sp_max	single	v_min to v_max	Level 1	Relay 4 overspeed alarm value. Range defined in 'Output config - factory'.
5564	do_sp_max	single	v_min to v_max	Level 1	Digital out overspeed alarm value. Range defined in 'Output config - factory'.
5566	r1_sp_min	single	v_min to v_max	Level 1	Relay 1 underspeed alarm value. Range defined in 'Output config - factory'.
5568	r2_sp_min	single	v_min to v_max	Level 1	Relay 2 underspeed alarm value. Range defined in 'Output config - factory'.
5570	r3_sp_min	single	v_min to v_max	Level 1	Relay 3 underspeed alarm value. Range defined in 'Output config - factory'.
5572	r4_sp_min	single	v_min to v_max	Level 1	Relay 4 underspeed alarm value. Range defined in 'Output config - factory'.
5574	do_sp_min	single	v_min to v_max	Level 1	Digital out underspeed alarm value. Range defined in 'Output config - factory'.

**Table F-13: SpeedSys300 ODS301 Modbus registers – output configuration – admin (continued)**

Address	Name	Data type	Range	Access	Description
5576	r1_acc_max	single	acc_min to acc_max	Level 1	Relay 1 max. acceleration alarm value. Range defined in 'Output config - factory'.
5578	r2_acc_max	single	acc_min to acc_max	Level 1	Relay 2 max. acceleration alarm value. Range defined in 'Output config - factory'.
5580	r3_acc_max	single	acc_min to acc_max	Level 1	Relay 3 max. acceleration alarm value. Range defined in 'Output config - factory'.
5582	r4_acc_max	single	acc_min to acc_max	Level 1	Relay 4 max. acceleration alarm value. Range defined in 'Output config - factory'.
5584	do_acc_max	single	acc_min to acc_max	Level 1	Digital out max. acceleration alarm value. Range defined in 'Output config - factory'.
5586	r1_acc_min	single	acc_min to acc_max	Level 1	Relay 1 min. acceleration alarm value. Range defined in 'Output config - factory'.
5588	r2_acc_min	single	acc_min to acc_max	Level 1	Relay 2 min. acceleration alarm value. Range defined in 'Output config - factory'.
5590	r3_acc_min	single	acc_min to acc_max	Level 1	Relay 3 min. acceleration alarm value. Range defined in 'Output config - factory'.
5592	r4_acc_min	single	acc_min to acc_max	Level 1	Relay 4 min. acceleration alarm value. Range defined in 'Output config - factory'.
5594	do_acc_min	single	acc_min to acc_max	Level 1	Digital out min. acceleration alarm value. Range defined in 'Output config - factory'.
5596	r1_sp_max_hyst	single	v_min to v_max	Level 1	Relay 1 overspeed alarm hysteresis. Range defined in 'Output config - factory'.
5598	r2_sp_max_hyst	single	v_min to v_max	Level 1	Relay 2 overspeed alarm hysteresis. Range defined in 'Output config - factory'.
5600	r3_sp_max_hyst	single	v_min to v_max	Level 1	Relay 3 overspeed alarm hysteresis. Range defined in 'Output config - factory'.
5602	r4_sp_max_hyst	single	v_min to v_max	Level 1	Relay 4 overspeed alarm hysteresis. Range defined in 'Output config - factory'.
5604	do_sp_max_hyst	single	v_min to v_max	Level 1	Digital out overspeed alarm hysteresis. Range defined in 'Output config - factory'.
5606	r1_sp_min_hyst	single	v_min to v_max	Level 1	Relay 1 underspeed alarm hysteresis. Range defined in 'Output config - factory'.
5608	r2_sp_min_hyst	single	v_min to v_max	Level 1	Relay 2 underspeed alarm hysteresis. Range defined in 'Output config - factory'.
5610	r3_sp_min_hyst	single	v_min to v_max	Level 1	Relay 3 underspeed alarm hysteresis. Range defined in 'Output config - factory'.
5612	r4_sp_min_hyst	single	v_min to v_max	Level 1	Relay 4 underspeed alarm hysteresis. Range defined in 'Output config - factory'.
5614	do_sp_min_hyst	single	v_min to v_max	Level 1	Digital out underspeed alarm hysteresis. Range defined in 'Output config - factory'.

**Table F-13:** SpeedSys300 ODS301 Modbus registers – output configuration – admin (continued)

Address	Name	Data type	Range	Access	Description
5616	r1_acc_max_hyst	single	acc_min to acc_max	Level 1	Relay 1 max. acceleration alarm hysteresis. Range defined in 'Output config - factory'.
5618	r2_acc_max_hyst	single	acc_min to acc_max	Level 1	Relay 2 max. acceleration alarm hysteresis. Range defined in 'Output config - factory'.
5620	r3_acc_max_hyst	single	acc_min to acc_max	Level 1	Relay 3 max. acceleration alarm hysteresis. Range defined in 'Output config - factory'.
5622	r4_acc_max_hyst	single	acc_min to acc_max	Level 1	Relay 4 max. acceleration alarm hysteresis. Range defined in 'Output config - factory'.
5624	do_acc_max_hyst	single	acc_min to acc_max	Level 1	Digital out max. acceleration alarm hysteresis. Range defined in 'Output config - factory'.
5626	r1_acc_min_hyst	single	acc_min to acc_max	Level 1	Relay 1 min. acceleration alarm hysteresis. Range defined in 'Output config - factory'.
5628	r2_acc_min_hyst	single	acc_min to acc_max	Level 1	Relay 2 min. acceleration alarm hysteresis. Range defined in 'Output config - factory'.
5630	r3_acc_min_hyst	single	acc_min to acc_max	Level 1	Relay 3 min. acceleration alarm hysteresis. Range defined in 'Output config - factory'.
5632	r4_acc_min_hyst	single	acc_min to acc_max	Level 1	Relay 4 min. acceleration alarm hysteresis. Range defined in 'Output config - factory'.
5634	do_acc_min_hyst	single	acc_min to acc_max	Level 1	Digital out min. acceleration alarm hysteresis. Range defined in 'Output config - factory'.
5636	acc_cutoff_speed	single	v_min to v_max	Level 1	Minimal speed for acceleration alarm processing. Below this speed acceleration alarms are not evaluated.
5638	aout_v_4ma	single	0 to 2100000	Level 1	Speed value for 4 mA output. Range defined in 'Output config - factory'.
5640	aout_v_20ma	single	0 to 2100000	Level 1	Speed value for 20 mA output. Range defined in 'Output config - factory'.
5642	aout_max	single	3.6 to 21.0	Level 1	Max limit value for Aout swing
5644	aout_min	single	3.6 to 21.0	Level 1	Min limit value for Aout swing
5646	aout_error	single	0 to 3.6	Level 1	Analog output error value (that is, output value in safe state)
5648	reserve	uint16		Level 1	
5649	crc_out_adm	uint16		Level 1	Parameter block CRC

## F.2.9 Output configuration – factory

Table F-14 describes the SpeedSys300 ODS301 Modbus registers related to the module output configuration – factory.

**NOTE:** This data block is intended/reserved for factory use only and should not be changed by end-users.

**NOTE:** The Modbus registers in this data block are read/write.

**Table F-14:** SpeedSys300 ODS301 Modbus registers – output configuration – factory

Address	Name	Data type	Range	Access	Description
6000	cal_aout_4ma	uint16	100 to 24000	Level 2	PWM value for 4 mA
6001	cal_aout_20ma	uint16	100 to 24000	Level 2	PWM value for 20 mA
6002	cal_ain_4ma	uint16	0 to 16383	Level 2	Current readback for 4 mA
6003	cal_ain_20ma	uint16	0 to 16383	Level 2	Current readback for 20 mA
6004	v_max	single	0 to 2100000	Level 2	Max. limit for speed settings
6006	v_min	single	0 to 2100000	Level 2	Min. limit for speed settings
6008	acc_max	single	-100000 to 100000	Level 2	Max. limit for acceleration settings
6010	acc_min	single	-100000 to 100000	Level 2	Min. limit for acceleration settings
6012	reserve	uint16		Level 2	
6013	crc_diag_fact	uint16		Level 2	Parameter block CRC

Key:

n.u. – Not used.

**THIS PAGE INTENTIONALLY LEFT BLANK**